

CarbonXtreme

AVANT FX

*Extreme 3D Conversion kit for the Freya,
X-Spec and Eagle line of helis.*

Assembly Instructions

(Las updated on July 20th. 2005)

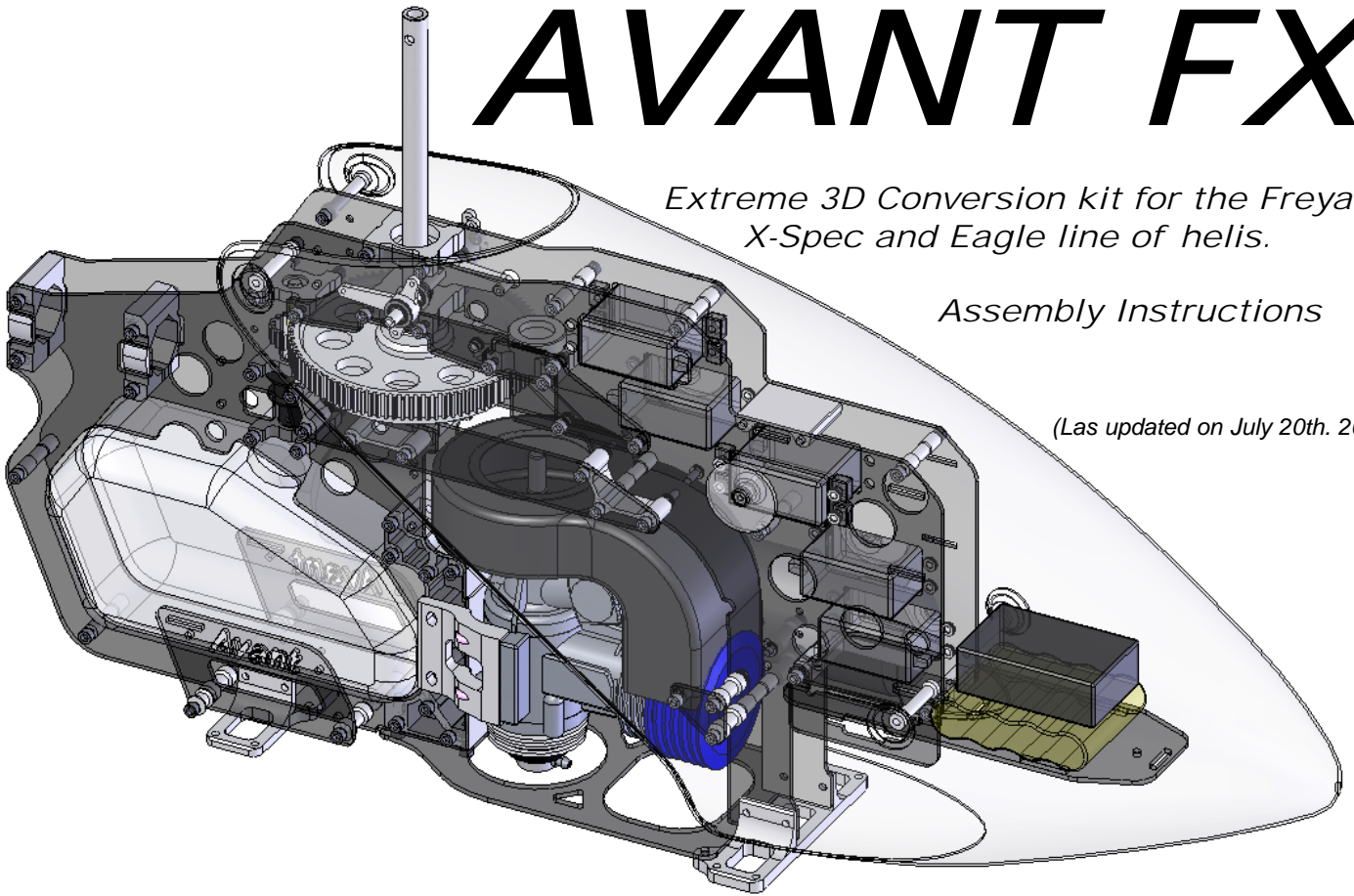

LIABILITY DISCLAIMER

This conversion kit is for a radio controlled helicopter. RC Helicopters are not toys. Moving parts can present a hazard to operators, bystanders and anyone or anything that could be reached by the helicopter. Improper operation, maintenance or assembly can potentially cause a helicopter to pose a danger to persons or objects including but not limited to the possibility to cause serious physical injury and even death. Under no circumstance should a minor be allowed to operate a radio controlled helicopter without the approval, supervision and direction of his parent or legal guardian.

Since the manufacturer or its agents have no control of the proper assembly and/or operation of the helicopter no responsibility or liability is assumed whatsoever including but not limited to ones generated by incidental or consequential damages.

The operator of the helicopter assumes all responsibility and liability that could be result from the correct or incorrect operation of the helicopter.

INDEX

- Step 1: Left Frame 4
- Step 2: Motor Mount Center 5
- Step 3: Metal Gyro Plate Mount 6
- Step 4: Mainshaft and left frame stiffener installation 7
- Step 5: Clutch bearing block installation 8
- Step 6: Tail pulley block and boom clamps installation 9
- Step 7: Left Tank sideplate installation 11
- Step 8: Battery Plate installation 13
- Step 9: Right frame and switch plate installation 14
- Step 10: CCPMswashplate preparation 16
- Step 11: CCPM System Installation 17
- Step 12: Frame Doubler Installation 19
- Step 13: Engine installation 20
- Step 14: Fan shroud supports installation 21
- Step 15: Back landing gear mount installation 22
- Step 16: Front landing gear mount installation 22
- Step 17: Bottom plate installation 23
- Step 18: Landing Gear installation 23
- Step 19: Right stiffener plate installation 24
- Step 20: Servo installation 25
- Step 21: Head modifications 29
- Step 22: Tailboom and rudder pushrod installation 32
- Step 23: Fins and Vinyl sticker installation 34
- Step 24: Vinyl sticker installation 35

Before you start assembling:

Using a piece of #400 sanding paper sand the edges of the carbon fiber pieces that will be close to any electronic or fuel tubing. Sharp edges can cut into the electric wires and since carbon fiber is conductive it can possibly create an electrical shortcut. Sharp edges can also cut fuel tubing creating leaks that could make the engine operation fail. Whenever you're ready to install a carbon fiber piece that will be close to servo wiring make sure to sand its edges to prevent wire chaffing.

Step 1: Left Frame

Bag #1 contents:

- 11 CX00-100-604 26mm frame spacers
- 2 CX00-100-650 30.5 mm Canopy Mounting Post
- 1 CX00-100-311 M3.5 plain nut
- 1 CX00-100-303 M3.5 Flat washer
- 11 CX00-100-420 M3x6 socket head screw
- 2 CX00-100-421 M3x8 socket head screw



Use the provided nut and washer from **Bag #1** and from your Hirobo kit use the [0414-128 collective pitch bolt](#).

Using some blue Loctite install the collective pitch bolt in the middle hole as indicated in the following picture. Other holes are provided in case your muffler's header forces the throttle pushrod onto a different location.

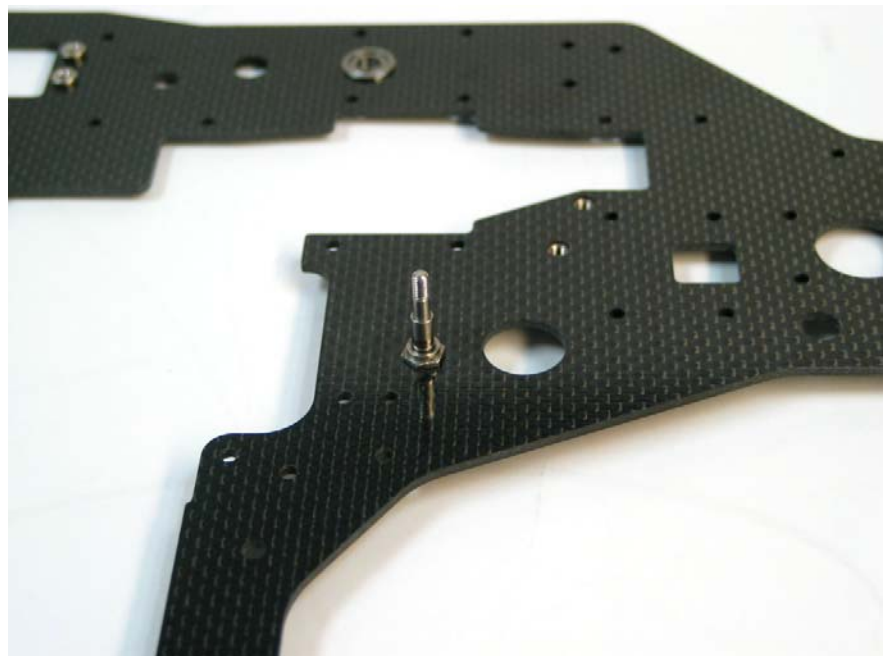

Avant FX Assembly Manual



Get the mounting posts from Bag #1.

Use two M3x8mm screws to install one post in the front and another one in the back as indicated in the picture to the right.

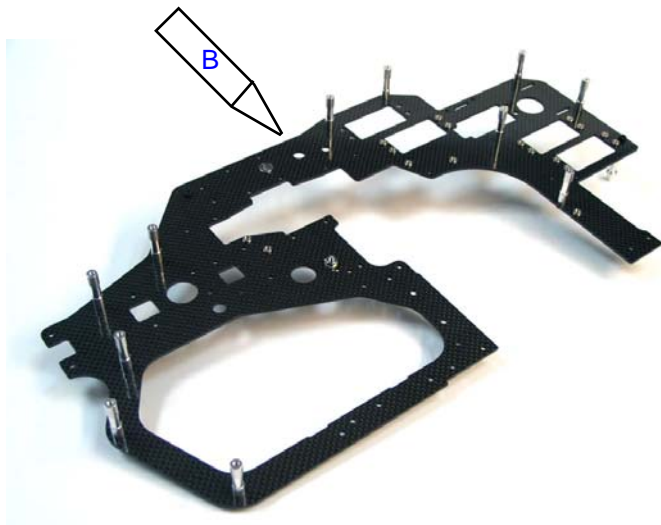

Flip over the left frame and using nine M3x6mm screws install the eleven 26mm cross members in the locations indicated in the picture to the left. Use Loctite when installing the screws.

Step 2: Motor Mount Center

Bag #2 contents:
 1 CX00-100-607 Motor mount center
 5 CX00-100-422 M3x10 socket head screw



Open **Bag #2** and install the motor mount center with the five M3x10mm screws provided. Notice that just above the top M4 hole and below the lower M4 hole there are two M3 holes. Those holes can be used for muffler mounting posts like the posts provided with the Hatori mufflers. The same holes in the other side are for the installation of optional header tanks by the use of a 17 mm spacer.

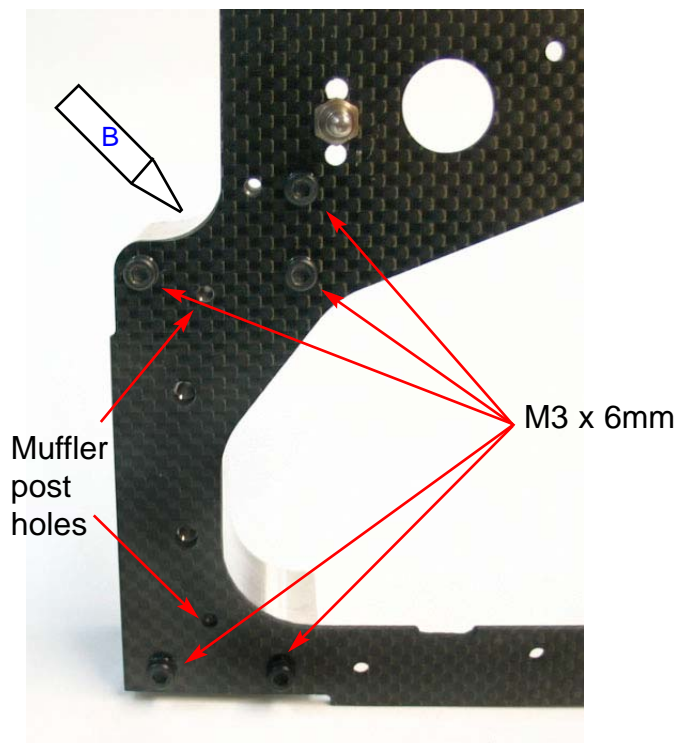

Step 3: Metal Gyro Plate Mount

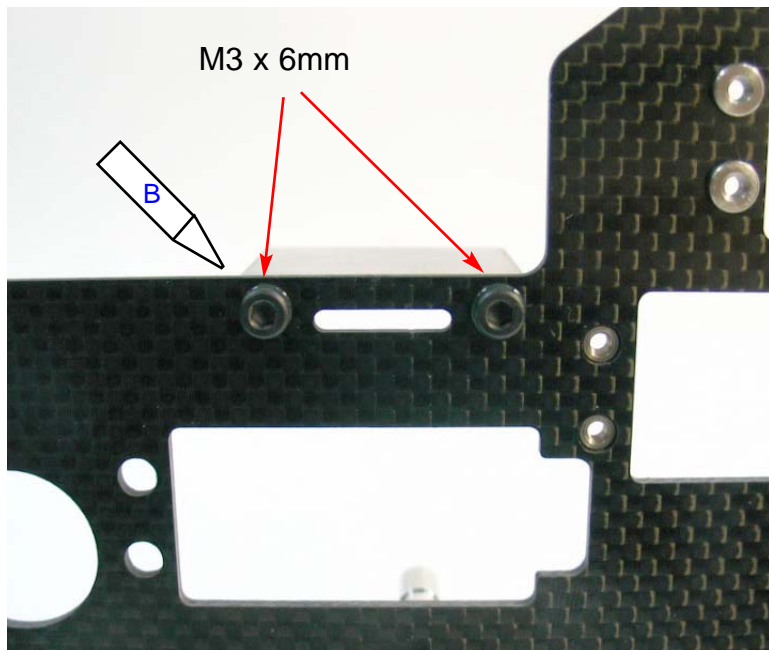

Bag #3 contents:
 1 CX00-100-609 Gyro mount
 2 CX00-100-422 M3x10mm socket head screw

Open **Bag #3** and using the provided two M3 x 10mm screws apply Blue Loctite to install the metal gyro mount as indicated in the picture to the left. This metal plate makes it unnecessary to use the metal plates included with the gyro sensors saving some weight.

At this point in the assembly process this is the way the left frame should look like.

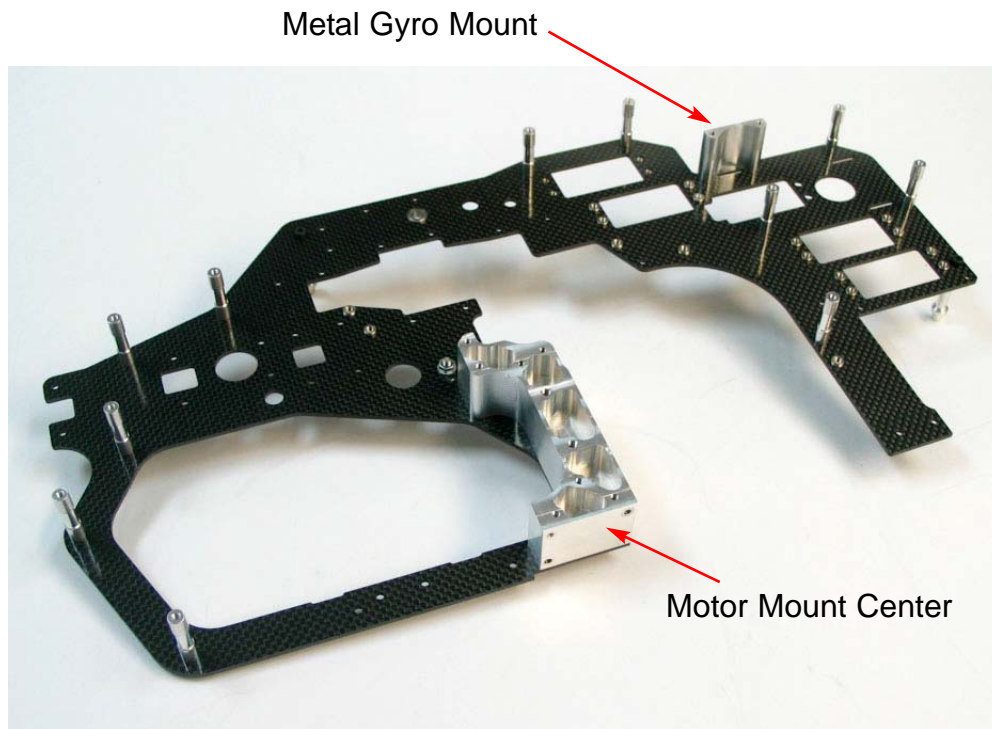

Step 4: Mainshaft and left frame stiffener installation



Bag #4 contents:

- 1 CX00-100-604 26mm frame spacers
- 1 CX00-100-610 Short stiffener
- 1 CX00-100-611 Medium stiffener
- 1 CX00-100-612 Long stiffener
- 4 CX00-100-420 M3x6 socket head screw
- 6 CX00-100-426 M3x20 socket head screw
- 1 CX00-100-427 M3x25 socket head screw
- 3 CX00-100-613 Mainshaft bearing blocks
- 1 CX00-100-634 Hollow Alloy Steel Main Shaft
- 1 CX00-100-509 Carbon fiber stiffener side-plate

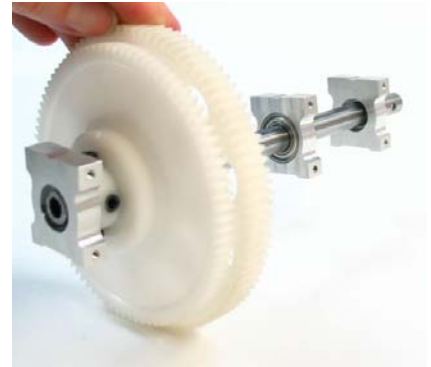

Install the main shaft into the [gear/clutch assembly](#) the same way the original hirobo shaft is installed. Notice which way the bearings are facing and slide the bearing blocks into the mainshaft as shown in the picture.

Using blue loctite use four M3 x 6mm screws and attach both the top mainshaft bearing block and the middle mainshaft bearing block in the location shown in the picture on the right.

Notice how the small block notches are facing the back of the helicopter. This orientation is necessary and applies to the 7.92 and 8.45 and 8.08 ratios

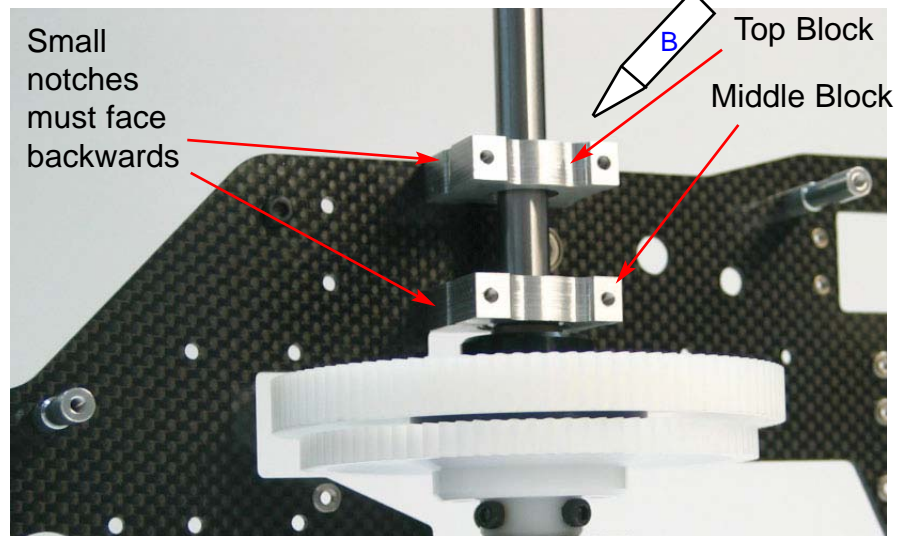

Using the remaining longer bolts and the stiffener spacers from the same bag #4 prepare the left frame stiffener plate as indicated in the picture to the right.

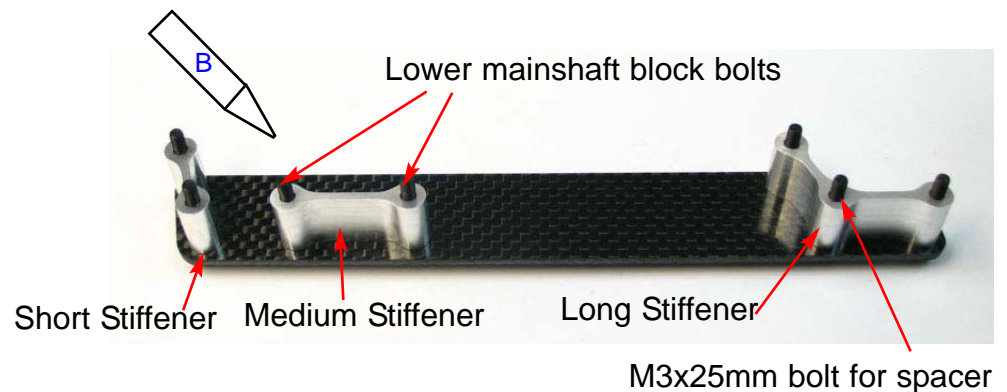

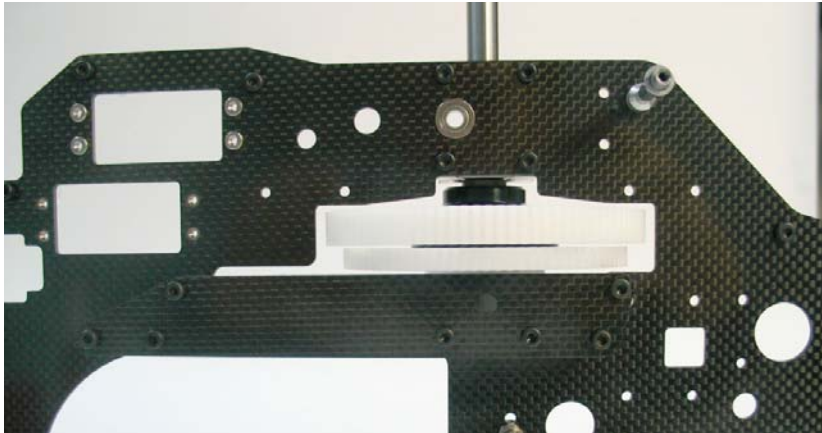

Add blue loctite to all the screws and install the plate as shown in the picture to the left.

Using blue loctite on the M3 x 25mm screw install a 26 mm spacer as indicated in the picture to the right.

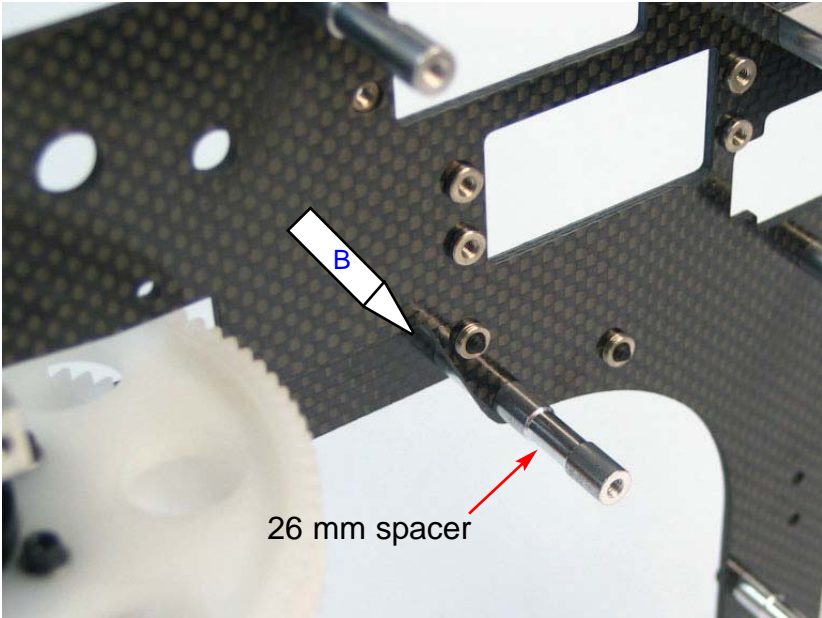

Step 5: Clutch bearing block installation



Bag #5 contents:
 1 CX00-100-615 Clutch Bearing block
 2 CX00-100-421 M3x8 Socket head cap screw

Use the clutch bearing block from bag #5 and install it with the provided screws as indicated in the picture. Don't use the blue Loctite yet since they will be adjusted later during the engine mounting step.

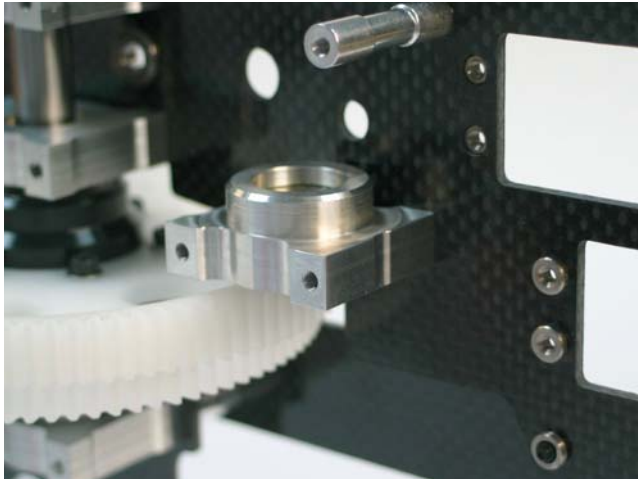

Note: For 8.08 ratios the clutch bearing block needs to be reversed and the small notch needs to be facing back instead to allow for more room for the larger 97 tooth gear.

Step 6: Tail pulley block and boom clamps installation



Bag #6 contents:

- 2 CX00-100-614 Tail Pulley Bearing block
- 2 CX00-100-616 Boom clamps
- 1 CX00-100-636 Tail pulley shaft
- 4 CX00-100-420 M3x6 Socket head cap screw
- 2 CX00-100-421 M3x8 Socket head cap screw
- 2 CX00-100-427 M3x35 Socket head cap screw



Place one side of the *Hirobo Tail pulley assembly* on top of a raised surface such as a set of pliers and using a 2 mm allen wrench extract the gear's *2 mm pin* by tapping it until it comes out through the other side.



Repeat the operation for the *tail pulley* as well and extract the *counter gear*, pulley and the *sleeve* out of the *Hirobo pulley shaft*.

Using the tail pulley shaft from bag # 6 install the *delrin gear* into the shaft and align the gear's upper hole with the shaft's pin hole. You can use a set of pliers to press the pin in place as it's shown with the *tail pulley* in the picture on the right.



Notice the orientation of the tail pulley shaft bearing blocks. It's important to have them oriented in the correct fashion so that they coincide

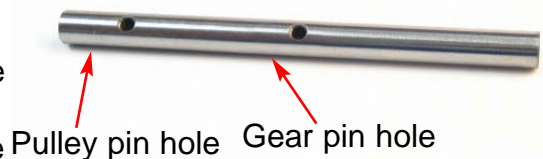

with the frame holes. The picture to the left is for bearing block orientation purposes.

The third bearing block should only be installed after the tailboom and belt are installed.



Slide the bearing block with the bearing opening facing the *tail pulley*. Install the *tail pulley* and slide the pin in place with a set of pliers as indicated on the picture to the right. Install the *brass sleeve* on top of the gear. If you're using 8.08 gear ratio then don't install the sleeve and read the special 8.08 ratio instructions and notes on the next page.

Apply blue loctite to four M3 x 6mm screws and install the tail pulley bearing blocks as shown in the picture on the left.



As shown on the picture to the left those using the [Hirobo torque tube system](#) won't need to install the sleeve.

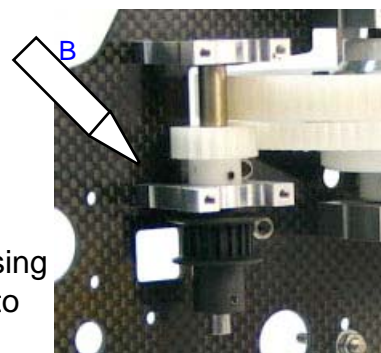

Note on the 8.08 ratio installation

If a 8.08 gear ratio is used (Hirobo 0404-057 97 tooth main gear+ 0414-374 12 tooth pinion) with a belt then no sleeve should be installed. Not using the sleeve might make it necessary to check for up/down play.

If it has some you can just use some hirobo 5mm x 7mm x 0.5T shim washers (part # 2506-032) to shim it in place. Alternatively if you don't want to get the shims you can also extend the frame holes of the middle block downwards a little bit to take care of any play if needed

no sleeve is installed

Tail pulley is held in between the middle and bottom block

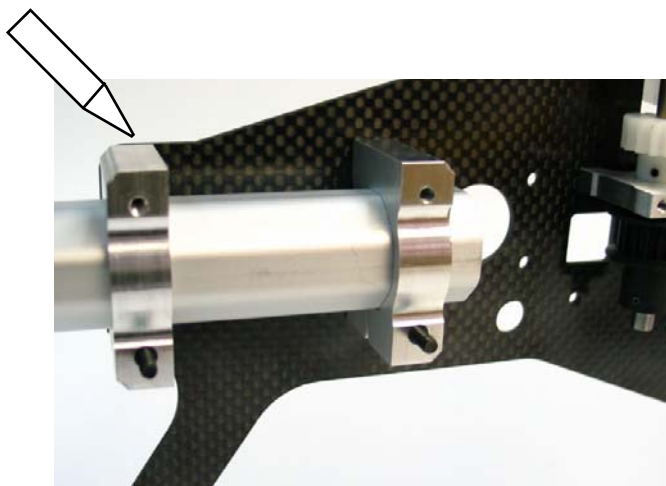
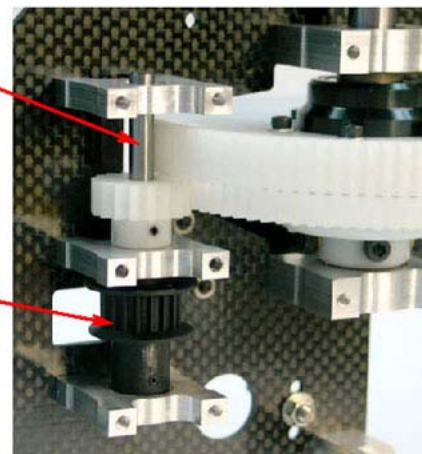

Using blue loctite install the boom clamps with two M3 x 8mm from bag #6. Slide the [Hirobo tailboom](#) between the two boom clamps to make sure they are aligned before tightening the screws. Make sure the threaded holes are pointing upwards and the through holes for the M3 x 35mm screws are pointing downward.

If you're planning in using a [Hirobo carbon tailboom](#) you will need the Boomclamping conversion kit for Eagle carbon tailbooms part number CX00-100-680. They can be differentiated from the ones for metal booms by the extra dot near the top of the boom aperture.



Step 7: Left Tank sideplate installation

Bag #7 contents:

- 1 CX00-100-507 Left tank plate
- 1 CX00-100-506 Right tank plate
- 1 Rubber cushion strip
- 2 CX00-100-604 26mm spacers
- 2 CX00-100-602 17mm spacers
- 1 CX00-100-601 7 mm spacers
- 1 CX00-100-302 M3 flat washer
- 1 CX00-100-429 M3x40 Socket head screw
- 1 CX00-100-427 M3x25 Socket head screw



Use four of the [Hirobo 404677-fuel tank cushions](#) and cut two of them as indicated in the picture to the above.

Install the cushions on the inside faces of the plates as indicated in the picture below.

Using a #400 grit sandpaper sand the inner edges to prevent cutting the velcro strap.

Using a #400 grit sandpaper sand the inner edges to prevent chafing the tank when the tank is pressurized

Using CA glue (crazy glue) install the non-cut cushions in these locations

Using CA glue (crazy glue) install the cut cushions in these locations

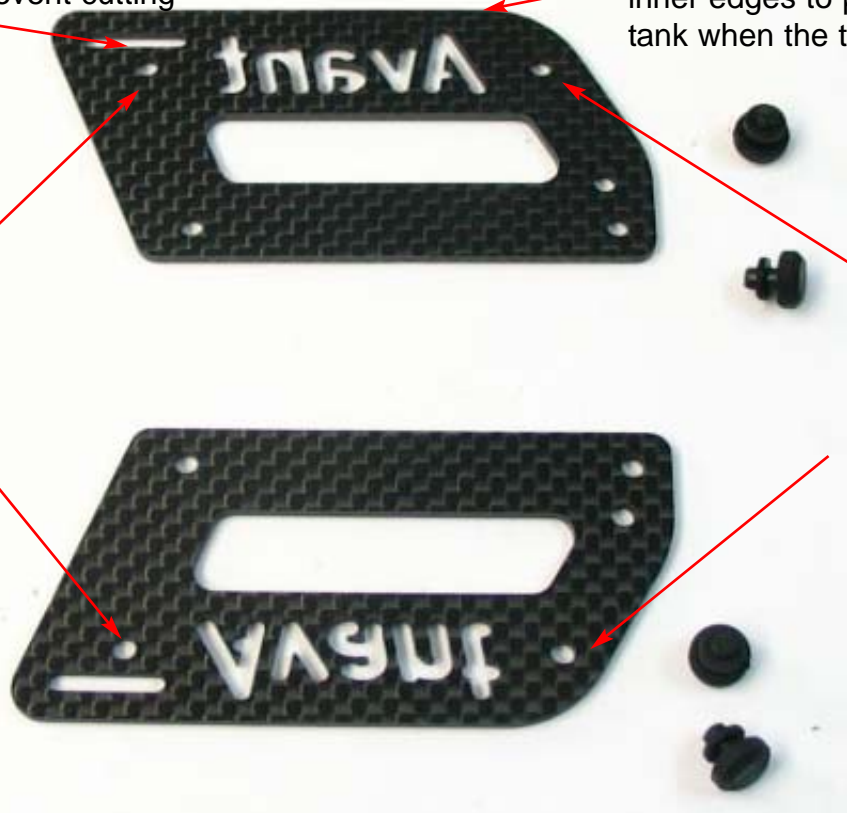

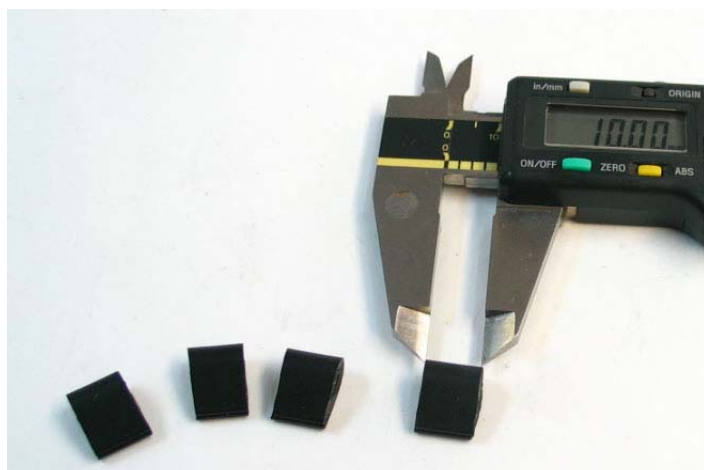

Cut the Neoprene strip into four pieces of 10mm length each as indicated on the picture to the left.

As shown on the picture to the right using CA glue install the Neoprene tank cushions in the two tank cushion notches provided on each frame.

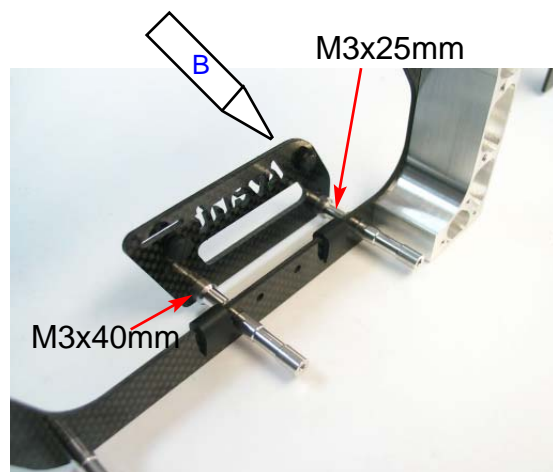

Use some blue Loctite pass a M3x25mm screw through the plate's front hole, a 17 mm spacer, the front hole of the frame and into a 26mm spacer.

Temporarily install a M3x40mm with an 3mm washer screw through a 7mm spacer, the back hole of the plate, a 17 mm spacer, the back hole of the frame and into a 26mm spacer. Don't use loctite yet because it will need to be readjusted for the boom support installation as seen on the picture to the right.

Set aside the other parts for the installation of the right side plate at a later step.



Step 8: Battery Plate installation.

Bag #8 contents:

- 1 CX00-100-508 Battery Tray - 1
- 2 CX00-100-705 Delrin battery support blocks
- 2 CX00-100-421 M3x8mm socket head screw
- 2 CX00-100-422 M3x10mm socket head screw

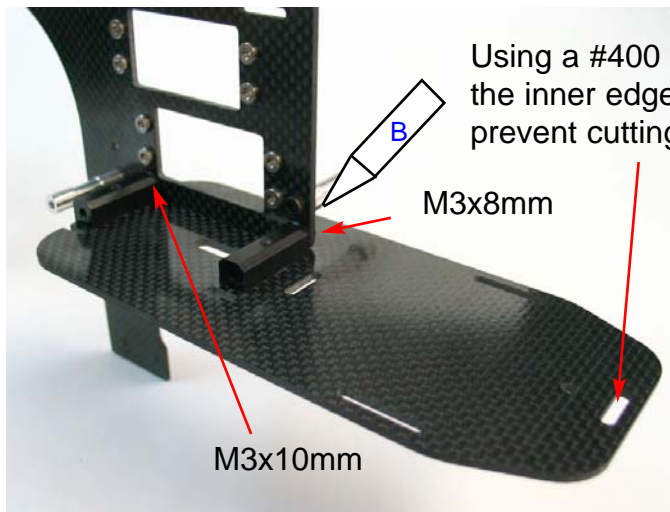

Using blue loctite install the Delrin battery support blocks to the battery plate by using two M3x10mm screws.

Using blue loctite attach the battery plate to the left frame with two M3x8mm screws as indicated on the picture to the left.

Install the *Hirobo mainshaft collar* in place but don't tighten it yet until both frames are installed and firmly secured.

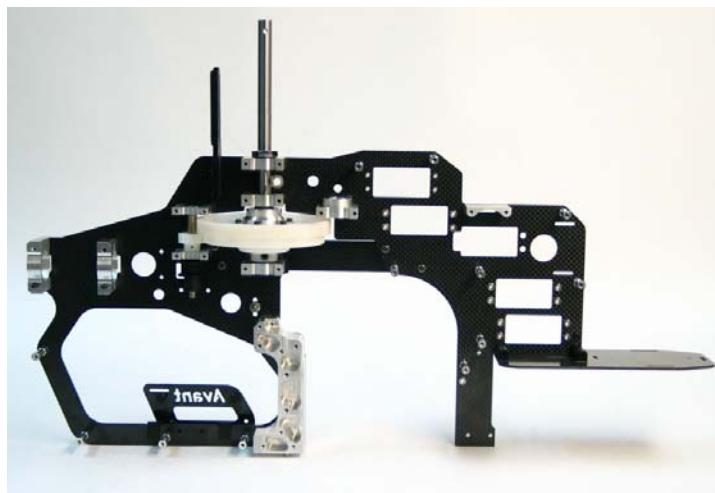
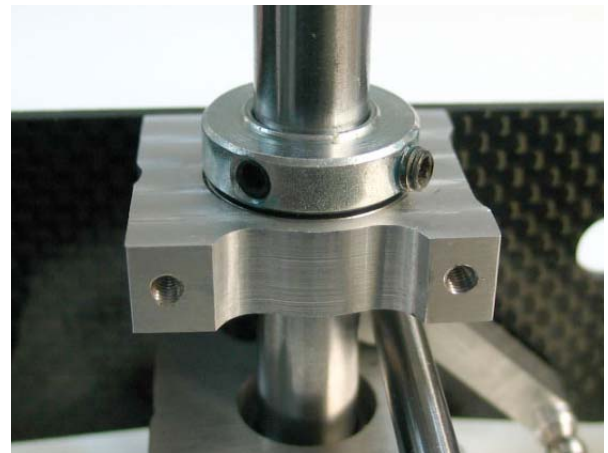

At this point your frame should look like the picture on the left.

Step 9: Right frame and switch plate installation



File around
this edge

Bag #9 contents:

- 1 CX00-100-513 Switch plate
- 2 CX00-100-650 30.5 mm Canopy Mntg Post
- 17 CX00-100-420 M3x6 Socket head screws
- 4 CX00-100-421 M3x8 Socket head screws
- 9 CX00-100-422 M3x10 Socket head screws
- 2 CX00-100-302 M3 Washers
- 2 CX00-100-320 M3 Locknuts



File the 3mm hole's outer edge of the [Hirobo 0404-713 fan shroud mounting bracket](#) so that it can swivel freely when mounted with an M3x6mm screw to the motor mount center as indicated in the picture to the right.

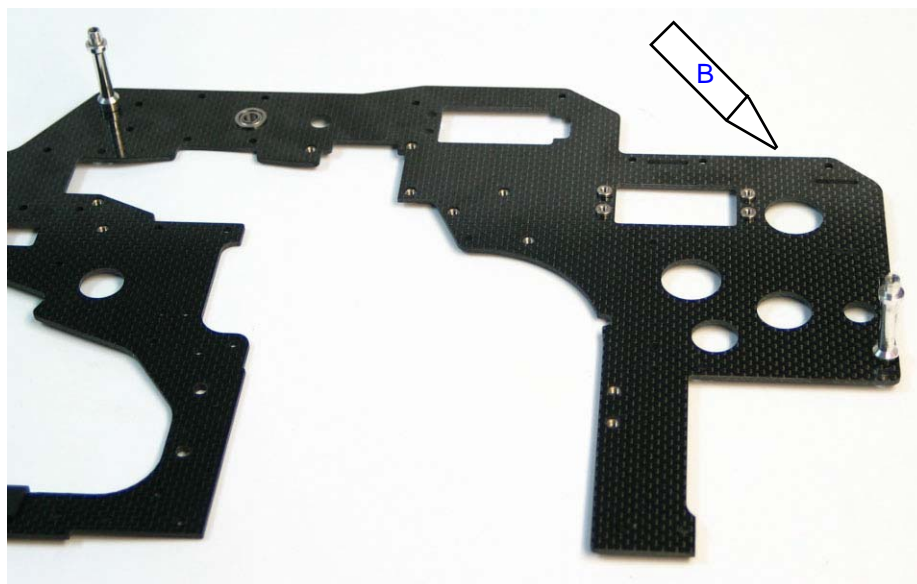
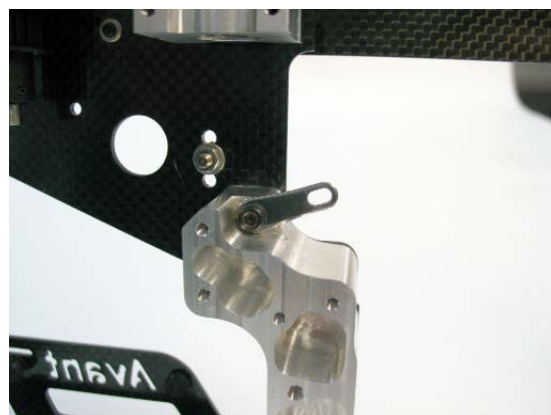

Get the mounting posts
from Bag #9.

Use two M3x8mm screws
to install one post in the
front and another one in the
back as indicated in the pic-
ture to the right.

Avant FX Assembly Manual

Using blue loctite install sixteen (16) M3x6mm screws in the locations marked with the arrows. If you're looking at an online color version of the manual use the red spots in the picture below. Install seven (7) M3x10mm screws as indicated below or by the yellow spots.

Using blue loctite install two M3x8mm screws in the locations marked with arrows or with a blue dot if you are looking at the color version.

Install an M3 washer and an M3 locknut in the spots marked with the corresponding arrows or a green spot on the picture to the right if the manual is in color.

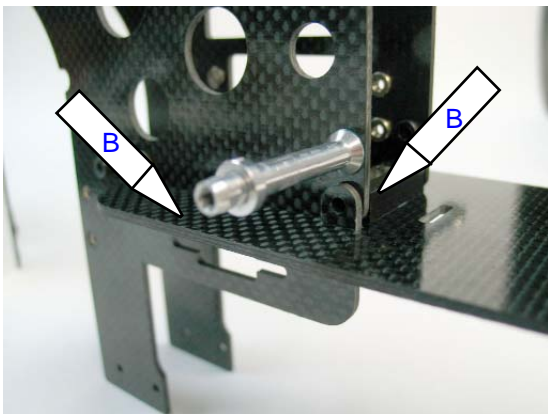
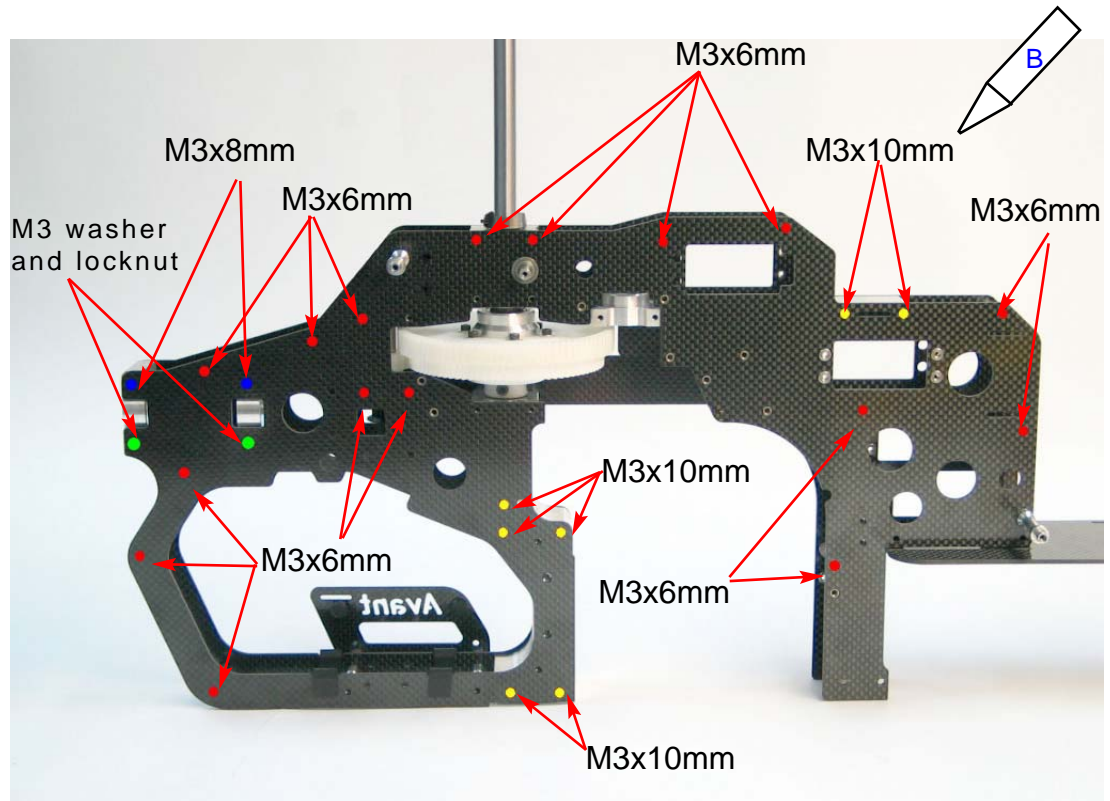

There are two places to install switches in the Avant FX. There is one on the receiver/battery plate for a switch that can be accessed from the bottom and one in the optional switch plate that can be accessed from the side. There are some servo system that use a switch for the receiver battery and another one for a 7V high voltage servo system.

If two switches are needed install the switch plate through the battery plate and attach it to the frame using two M3x10mm screws as shown on the picture to the left otherwise just use the screws to bolt the frame to the plastic mounts.

Now that the frames are installed go back to the mainshaft collar and while pulling the shaft upwards push the collar downwards and using blue loctite tighten the setscrews in place.



Note: It is very important there is NO UP/DOWN PLAY WHATSOEVER in the main shaft or the helicopter will display sudden unexpected collective pitch responses while flying derived from such play

Step 10: CCPM swashplate preparation.



Bag #10 contents
 1 CX00-100-623 120 degree CCPM swashplate
 1 CX00-100-624 CCPM Swashplate guide pin
 3 CX00-100-410 M2x6 socket head screws



Cut two slits on opposite sides of the *Freya swashplate*.



Using a flat screwdriver as a wedge insert a screwdriver into the slits as a wedge and rotate it to break the plastic outer casing off. as indicated in the pictures.

Unscrew all the Hirobo balls from the swashplate inner and outer rings.



Use a swab to apply a thin coat of blue or green Loctite around the inside of the swashplate ring and around the outside of the bearing case making sure there is no excess that could potentially get inside the bearing and lock it in place. Slide the bearing in place and install three M2x6mm socket head screws as a security measure.

Re-install the *Hirobo swashplate balls* back into the inner swashplate ring as well as three of the short ones used in the plastic ring on the outer ring as shown in the picture below.

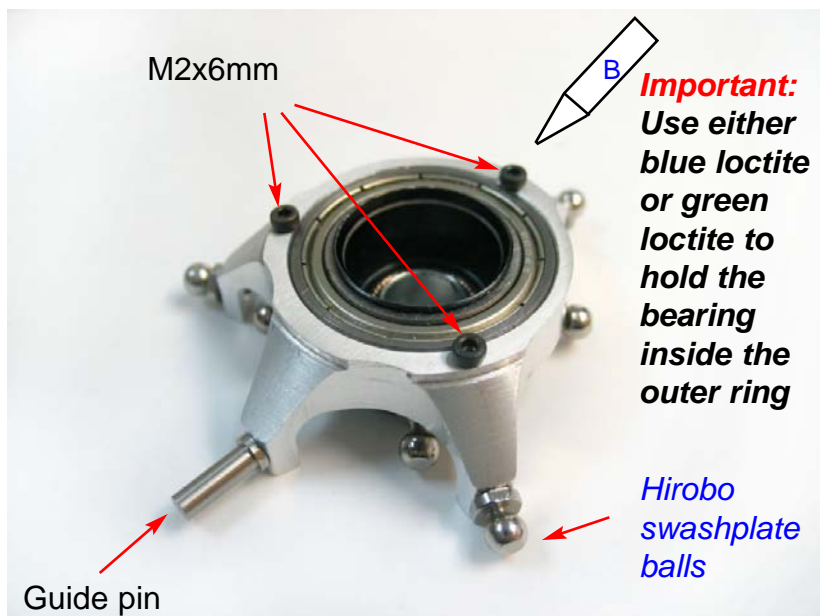

WARNING !!!

The Swashplate bearing is held in place by the Loctite not the screws. The M2x6mm screws are just a security measure. Do not use the three security screws to hold the bearing in place without using blue or green Loctite to secure the swashplate in place. Failing to use the Loctite could result in a failure that could potentially cause serious injury or death.

Step 11: CCPM System Installation

M2.5x8 and M2.5 flat washer

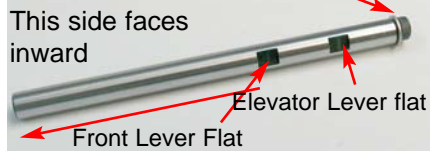

Bag #11 contents:

- 1 CX00-100-617 Elevator Lever
- 1 CX00-100-618 Front Lever
- 1 CX00-100-620 CCPM Shaft collar
- 1 CX00-100-621 5mm ID short spacer
- 2 CX00-100-619 Aileron/Pitch lever
- 1 CX00-100-635 CCPM Shaft
- 3 CX00-100-440 M4 Setscrew
- 1 CX00-100-403 M2.5x8 screw
- 1 CX00-100-301 M2.5 flat washer
- 1 CX00-100-703 CCPM delrinGuide
- 4 CX00-100-421 M3 x 8mm Socket head cap screws



From **Bag #11** select the CCPM shaft. Using blue Loctite Install the M2.5x8 screw and M2.5 flat washer at the end of the shaft as shown in the picture.

Install three [2525-006 5mm balls](#) in the aileron lever with their [2532031-M2 X 6 cap screws](#).

Install two [2525-006 5mm balls](#) in the aileron lever with their [2532031-M2 X 6 cap screws](#) into the elevator level.

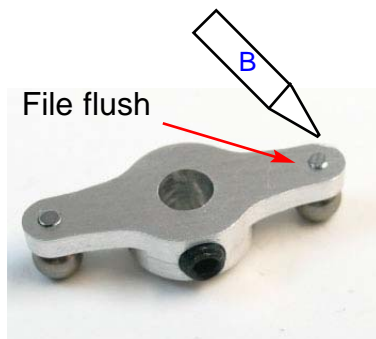

Once the Elevator lever balls are installed file the screw ends flush so that they clear the M3 socket heads from the left frames.



Install the aileron lever and the elevator lever in place. Using blue loctite install the M4 flat bottomed setscrew in the elevator lever and make sure the flat coincides with the bottom of the setscrew. Slide the elevator arm towards the Aileron arm just enough to secure the aileron arm between the screw and the elevator arm without play. Tighten the M4 setscrew in place and check for no sliding play on the aileron arm.

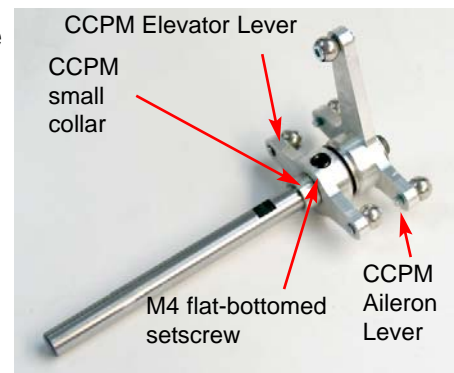

Using blue loctite on a [2532031-M2 X 6 cap screw](#) Install either a [Hirobo 2525007 5mm ball with stand](#) or a regular [2525-006 5mm ball](#) with a 2mm washer on the front lever.

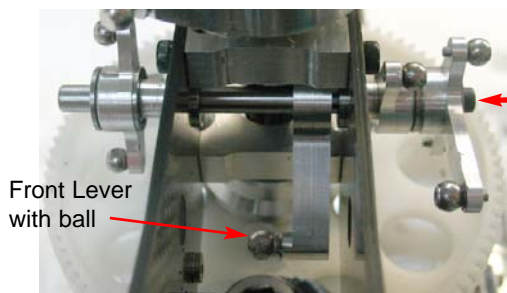

Front Lever
with ball

Install the M4 setscrew in the front lever. Pass the CCPM shaft assembly through the left frame's flanged 5 mm ID bearing and then through the Front lever and through the right frame's 5mm ID flanged bearing. Install the long ccpm shaft spacer and the Pitch lever as shown in the picture to the left.

Install the M4 setscrew into the collar and install the collar at the end of the CCPM shaft. Before tightening the collar apply pressure on the M2.5 screw inwards at the other end of the shaft so that the assembly rests against the frame's 5mm ID flanged bearing. At the same time push the collar inwards so that the pitch lever is pressed against the long spacer and no play is allowed. Tighten the M4 setscrew while holding the assembly as explained. Align the front lever so that the ball itself is located in the middle between the two frames. Using a long wrench reach the Front lever's M4 setscrew and tighten the lever in place. Make sure that the setscrew coincides with the shaft's front lever flat.

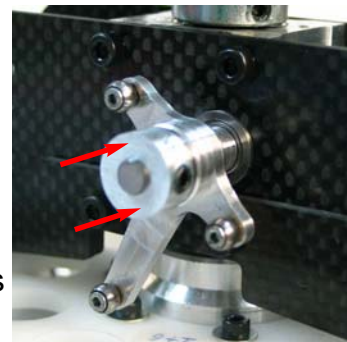

Notice that the setscrews are not cup but flat bottomed. This allows the lever to self-align to the flats when tightened. If they are ever replaced remember to use flat bottom setscrews or the levers won't be truly aligned to each other.

Slide the Swashplate in place and install the black Delrin CCPM swashplate pin guide by using the four M3x8mm screws and blue loctite as shown in the picture to the left.

M3x8mm (two on each side)

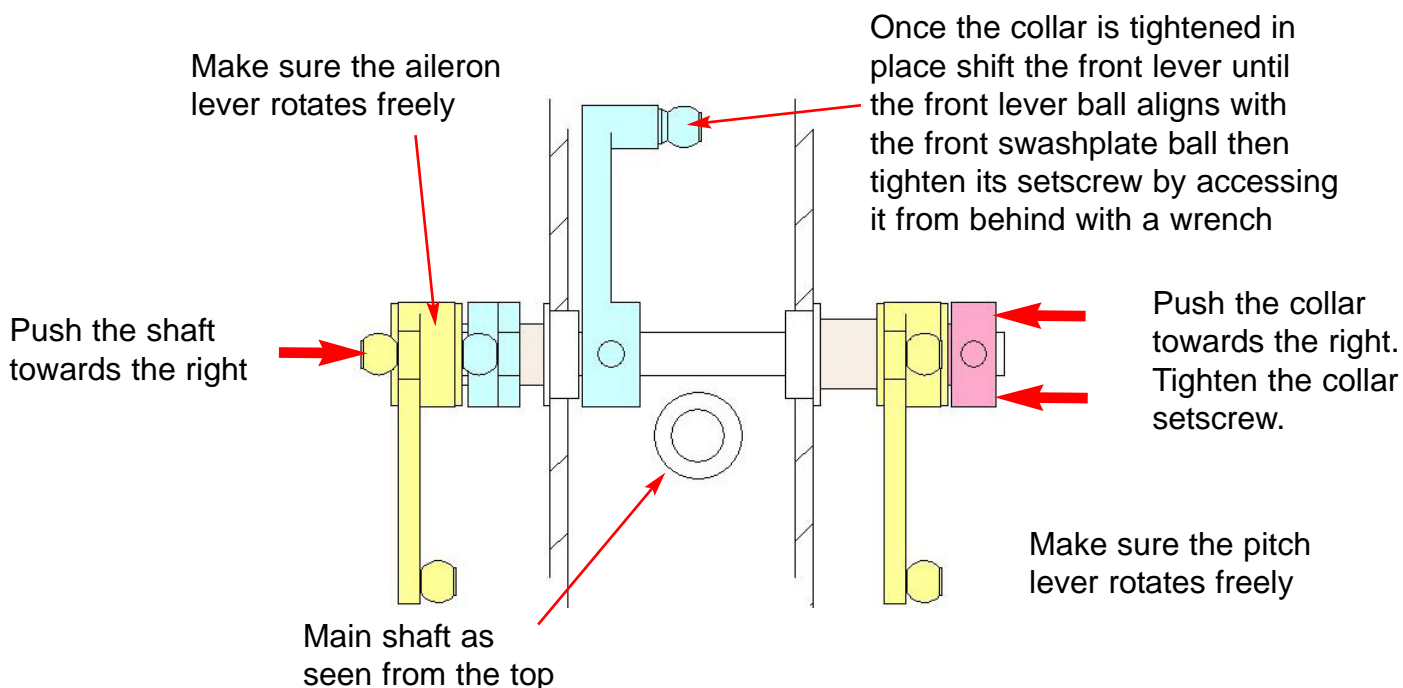

Step 12: Frame Doubler Installation

Thinner Edge faces forward



Bag #12 contents:

- 1 CX00-100-514 Frame doubler plate
- 1 CX00-100-511 Clutch block spacer plate
- 3 CX00-100-420 M3x6mm socket head screws
- 3 CX00-100-421 M3x8mm socket head screws
- 2 CX00-100-422 M3x10mm socket head screws



Make sure the clutch block spacer plate is aligned so the hole with the thinner edge faces forward.

The clutch plate allows access to the engine from the side for those cases when you want to access it without taking the fan shroud off.

The other way to access the engine is from the bottom of the helicopter.

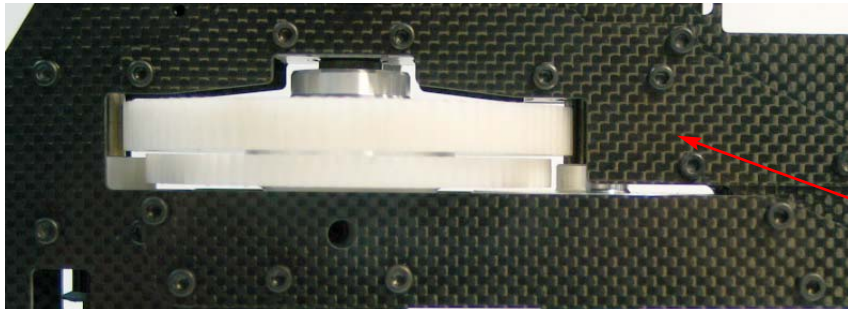
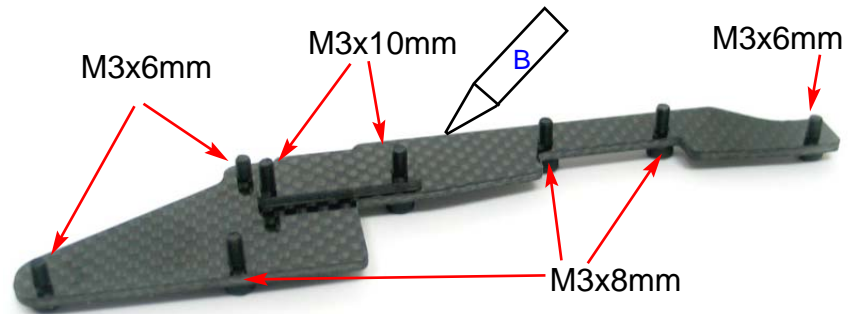

Using blue loctite on all screws install the plates as shown at the picture to the left.

Step 13: Engine installation

Bag #13 Contents:

2 CX00-100-608 Motor mount sides

4 CX00-100-433 M4x12mm socket head screws

4 CX00-100-434 M4x14mm socket head screws

Install the engine clutch stack using the *Hirobo parts* as per your *Freya manual*. Unscrew the two front screws that hold the clutch bearing block in place and loosen the back ones so that you can rotate the front of the block upwards about 15 degrees.

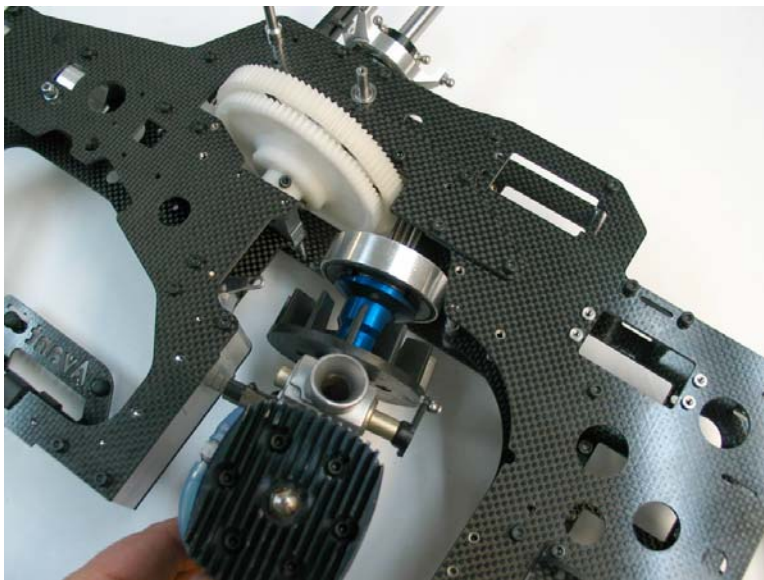

Insert the engine with the clutch stack installed into the clutch bearing block.

After inserting the engine rotate it into place. For best alignment don't secure the front screws of the clutch block until the engine is secured into the engine mount.

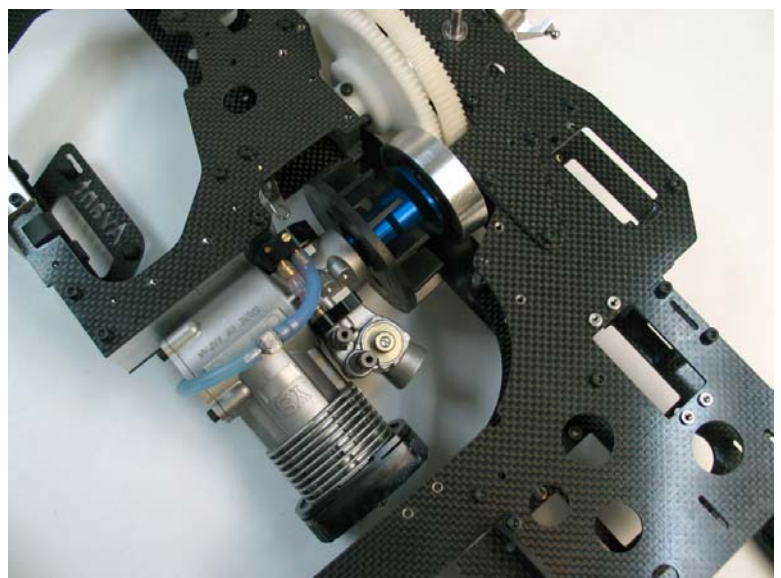

Avant FX Assembly Manual

Using blue loctite and two M4x14mm screw attach the engine mount sides to the engine. Repeat the process for the other side. By now your engine will have both motor mount sides installed and it should be able to slide up and down along the vertical axis. Push the engine upwards slightly until there is a bit of pressure applied to the clutch so that the small starter shaft's o-ring will prevent any play in the clutch bell.

Install the M4x12mm screws into the motor mount center with blue loctite to secure the engine in place.

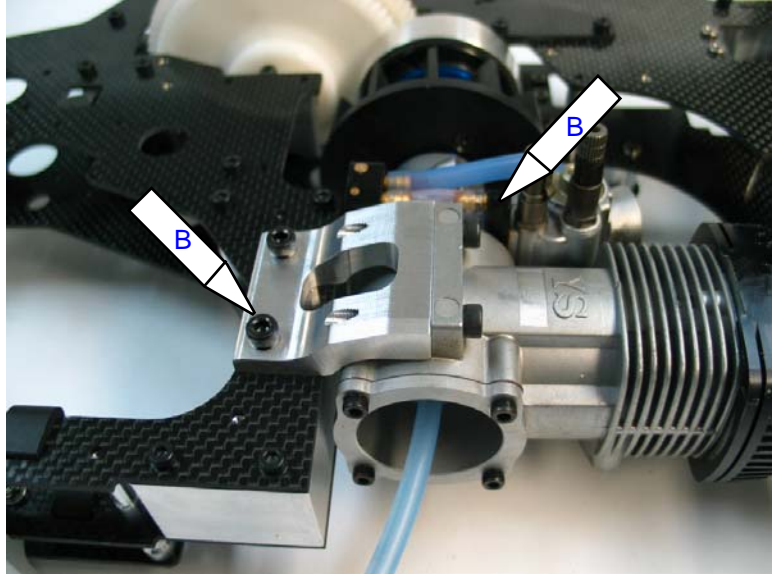

Add blue loctite to all the clutch bearing block screws and tighten them in place.

Note: For 8.08 ratios you will need to add one M4 flat washer for each bolt between the engine and motor mount to compensate for the larger main gear. You also need to flip the clutch bearing block so that the notch faces back.

Step 14: Fan shroud supports installation.

Bag #14 contents:

- 2 CX00-100-512 Fan shroud carbon plates
- 4 CX00-100-602 17mm spacers
- 4 CX00-100-427 M3x25mm Socket head screws
- 2 CX00-100-420 M3x6mm Socket head screws

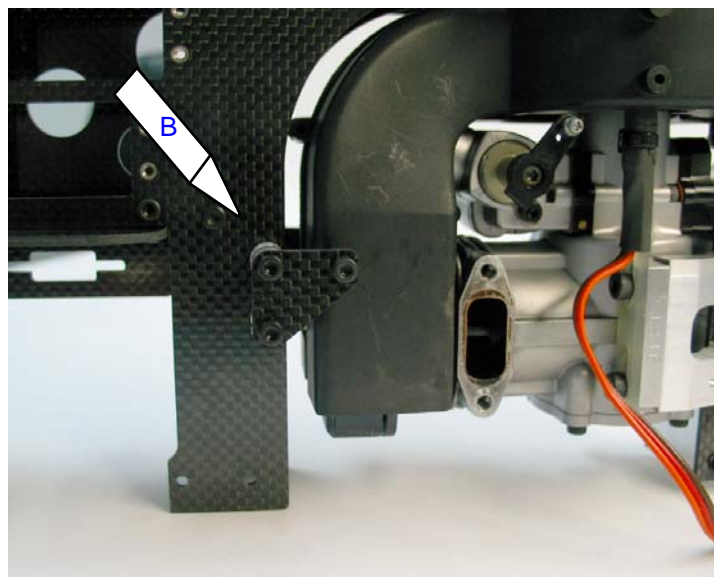

Install the [0404-044 Hirobo fan shroud](#) in place as per the Hirobo instructions. Remember to cutoff the fan shroud's mounting post at the line marked in the plastic as per the instructions. This will make the distance from post to post edge 64mm.

Remove the M3x6 screws that hold the 26mm spacer and with some blue Loctite install the plates using the M3 x 25mm screws through the plates and 17 mm spacers and into the threaded insert in the lower hole and a 26mm spacer in the upper hole. Repeat the process for the other side. Install a M3x6mm screw on each side through the plates and into the fan shroud mounting post.

Step 15: Back landing gear mount installation.

Bag #15 contents:

- 1 CX00-100-606 Back landing gear mount
- 4 CX00-100-422 M3x10mm socket head screws
- 4 CX00-100-302 M3 washers
- 4 CX00-100-320 M3 locknuts



Install the back landing gear mount with four M3x10mm screws with washers and locknuts as shown in the picture to the left.

The fit is tight on purpose so you might need to compress the frames a little bit to make the landing gear mount slide into place. Rounding the top inner edges of the mount can help starting it.

Step 16: Front landing gear mount installation.

Bag #16 contents:

- 1 CX00-100-605 Front landing gear mount
- 4 CX00-100-422 M3x10mm socket screws
- 4 CX00-100-302 M3 washers
- 4 CX00-100-320 M3 locknuts



Install the Front landing gear mount with four M3x10mm screws with washers and locknuts as shown in the picture to the right.

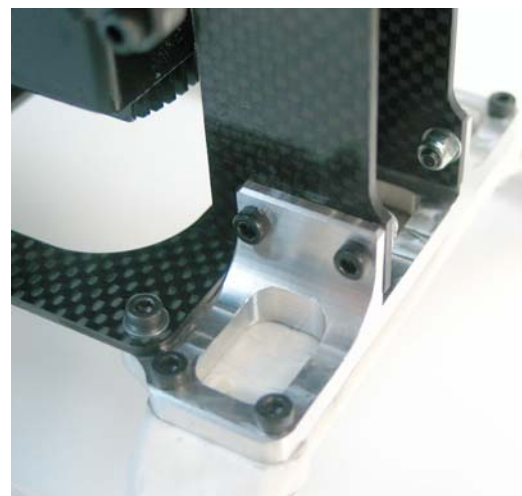



Step 17: Bottom plate installation.

Bag #17 contents:

- 1 CX00-100-508 Bottom Plate
- 4 CX00-100-421 M3x8mm socket head screws
- 2 CX00-100-422 M3x10mm socket head screws
- 4 CX00-100-302 M3 flat washers
- 2 CX00-100-320 M3 locknuts

17

M3x12mm + M3 washers + locknut

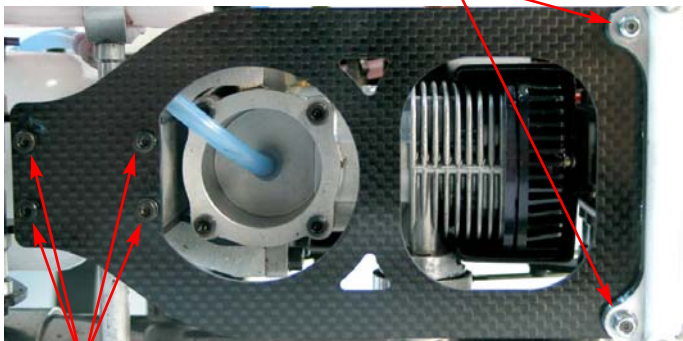

M3x8mm

Using Blue loctite Install the plate using four M3x8mm screws for the four holes in the back of the plate. Install two M3 washers on two M3x12mm screws and insert them from the top through the bottom plate and through the front landing gear mount holes. Use another M3 washer and install an M3 locknut on each screw.

Step 18: Landing Gear installation.

Bag #18 contents:

- 8 CX00-100-423 M3x18mm socket head screws
- 8 CX00-100-302 M3 washers
- 8 CX00-100-320 M3 locknuts



Attach the *Hirobo Landing gear* to the landing gear mounts using eight M3x18mm with their corresponding M3 washers and M3 locknuts as shown in the picture to the right.

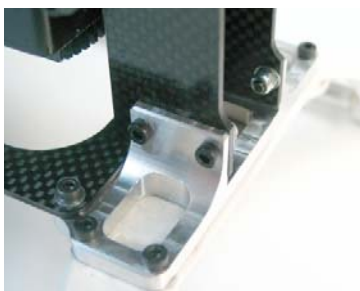

Step 19: Right stiffener plate installation.

Bag #19 contents:

- 1 CX00-100-509 Frame stiffener plate
- 6 CX00-100-426 M3x20mm socket head screw
- 1 CX00-100-427 M3x25mm socket head screw (for 26 mm spacer installation)
- 1 CX00-100-610 Short stiffener spacer
- 1 CX00-100-611 Medium stiffener spacer
- 1 CX00-100-612 Long stiffener spacer

Use six M3x20mm bolts, an M3x25mm bolt and the stiffener spacers from bag #20 to prepare the right frame stiffener plate as indicated in the picture below.

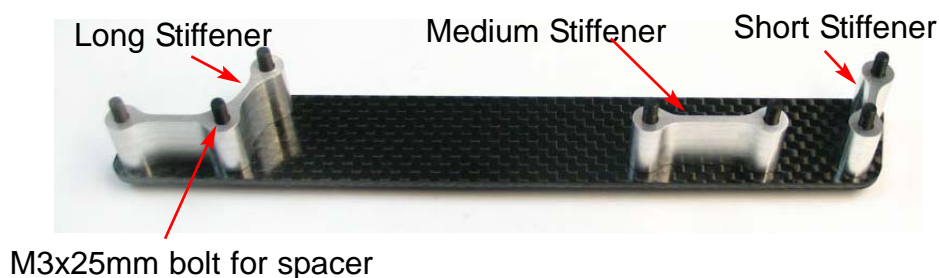

Using blue loctite install the plate in place as shown in the picture.

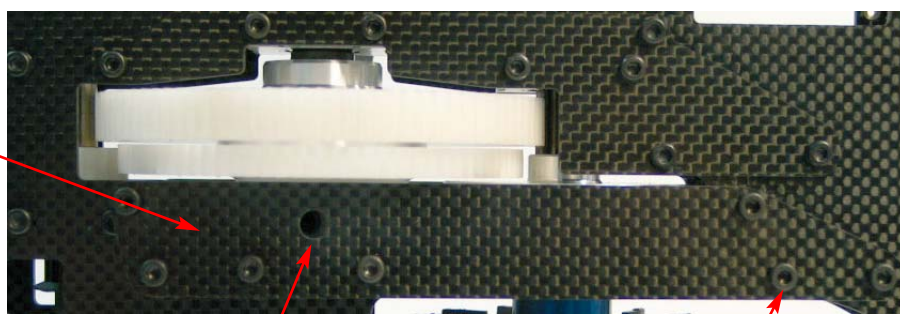

Access hole for mainshaft
mounting screws (one each side)

M3x25mm screw

Step 20: Servo installation.

Bag #20 contents:

- 4 CX00-100-629 2.2 x 80mm pushrods
- 1 CX00-100-631 2.2 x 100mm pushrod
- 2 CX00-100-632 2.2 x 135mm pushrods
- 1 CX00-100-633 2.2 x 170mm pushrod
- 20 CX00-100-450 M2.5x10mm Phillips round head plated screw
- 20 CX00-100-301 M2.5 washers
- 1 CX00-100-601 7 mm spacer
- 1 CX00-100-423 M3x12 socket head cap screw

Insert the front servo between the frames as shown in the following pictures:

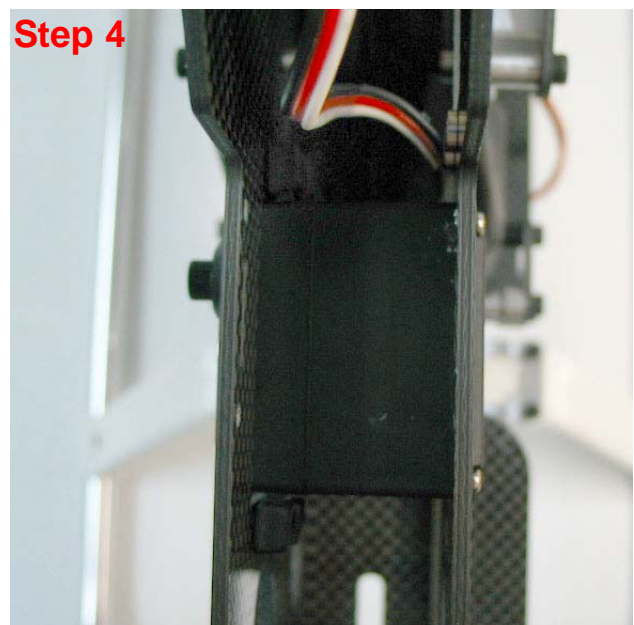
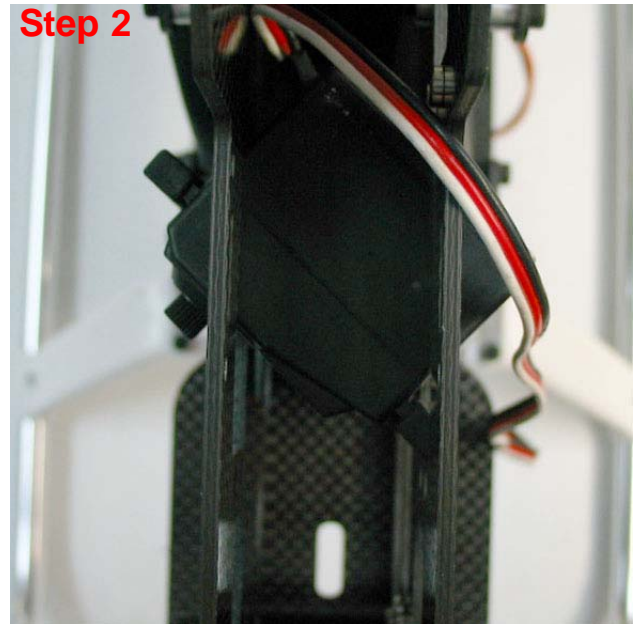
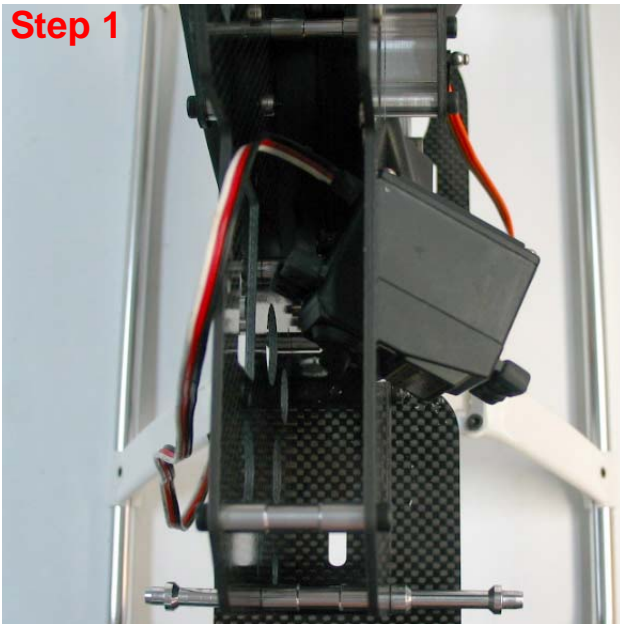

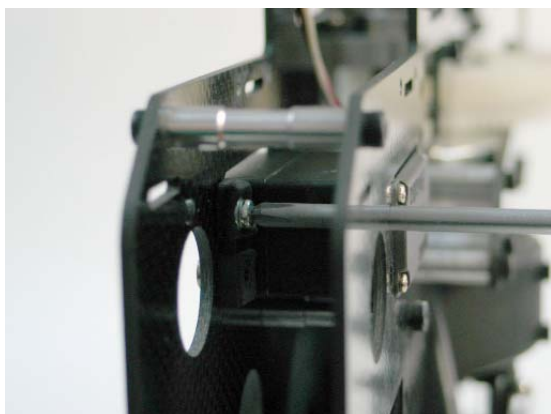

Secure the servo with four M2.5x10mm phillips round head screws and M2.5 washers. Screwdriver access to the inner side of the frame is provided through through holes or openings on the opposite side frame.

Install a servo wheel with holes located 12.5mm away from the center. Use two [2525-006 Hirobo 5mm balls](#), [2532-031 M2x6mm cap screw](#) and [2506-017 M1.7 flat washers](#). Install two [Hirobo ball links](#) at both ends of two 135 mm pushrods.

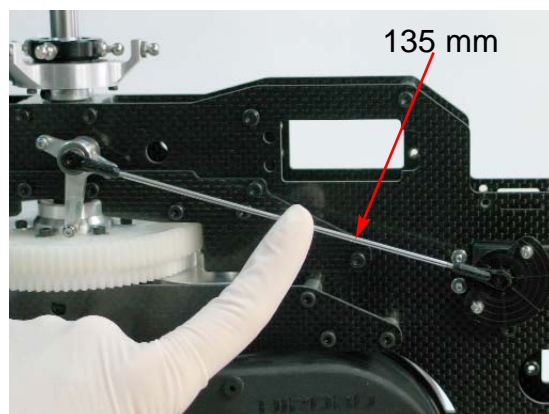

WARNING !!!

It's very important that the distance is 12.5mm away from center on all CCPM servos or the lever won't copy the servo movement exactly as it's supposed to and unwanted forces will wear out the servo's bearing and shaft.

Present the rods against the centers of rotation of the lever and the servo wheel and adjust the ball links to the match the centers

Install the pushrods in place and check that there is a 90 degree angle between the rod and the line between the ball links and the centers of rotation.

Apply the same rule to all the CCPM rods and servos.

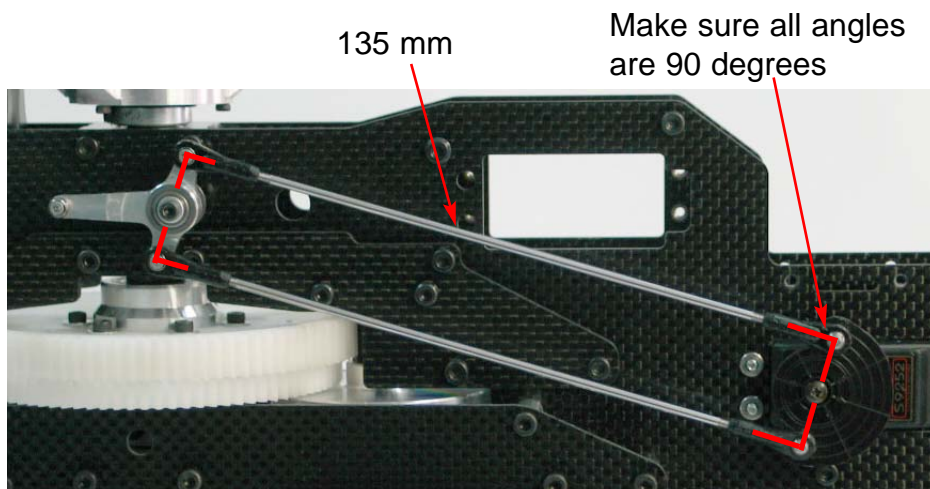

Avant FX Assembly Manual

Insert the top servo between the frames following the steps indicated in the next 4 pictures.

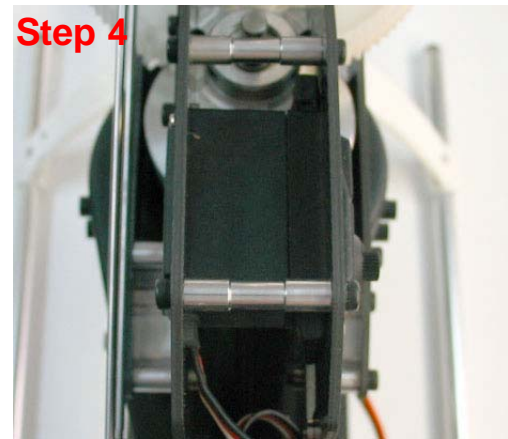
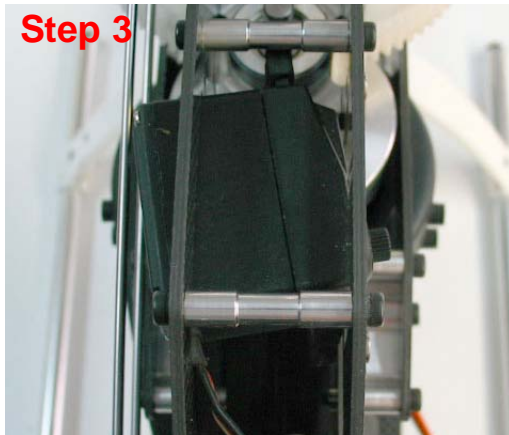
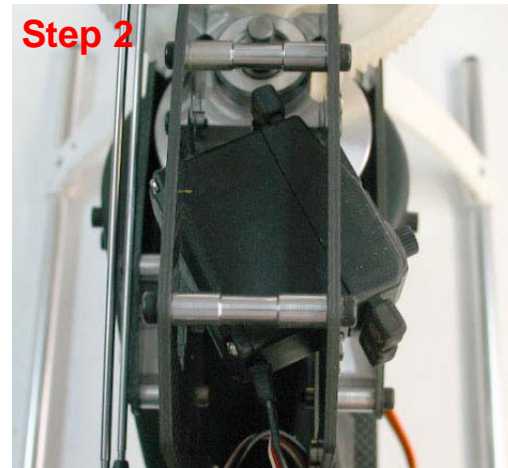
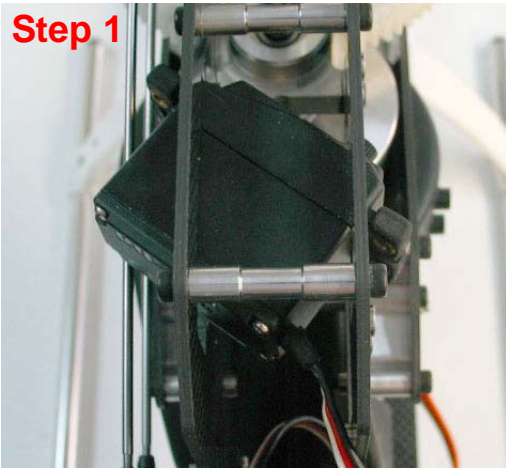

Trim the diameter of a servo wheel and install two Hirobo [2525-007 - 5MM Ball with stand](#), [2532-031 M2x6mm cap screw and 2mm nut](#) on the REVERSE side of the servo wheel as shown in the picture to the right. Apply blue loctite when installing the 2mm nut.



Install the wheel on the servo and make sure the ball face inward towards the left frame. If the screws protrude above the 2mm nuts file them to make them flush with the nuts.

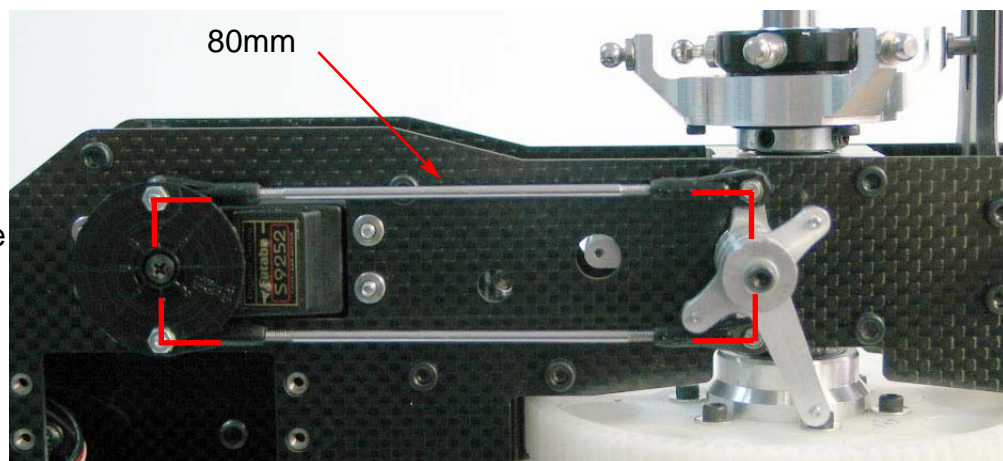

Install two *Hirobo ball links* on two 80 mm long pushrods and

adjust them to match the distance between the servo wheel center and the lever's center of rotation. Install them as in the picture to the right and make sure there is a 90 degree angle between the rod and a line between the ball links and the centers of rotation.

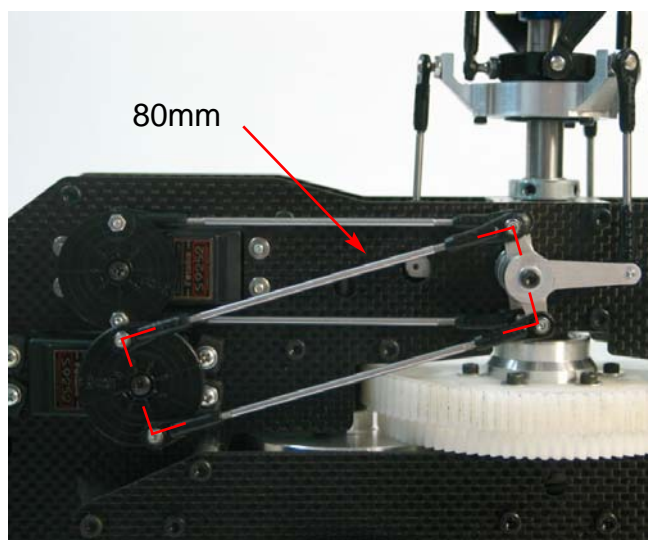

Install two *Hirobo ball links* on two 80 mm long pushrods and adjust them to match the distance between the servo wheel center and the lever's center of rotation. Install them as in the picture to the left and make sure there is a 90 degree angle between the rod and a line between the ball links and the centers of rotation.

When installing the tail pushrod use the supplied brass sleeve in the front ball link. See Appendix A for instructions



Install two *Hirobo ball links* on a 100 mm long pushrods and adjust them to match the distance between the servo wheel center and the carburetor lever's center of rotation. Install them as in the picture to the right and make sure there is a 90 degree angle between the rod and a line between the ball links and the centers of rotation. Repeat the procedure for a 170mm rod and the rudder servo. Install a *Hirobo bellcrank* in the *collective pitch bolt* that was installed in step 1.

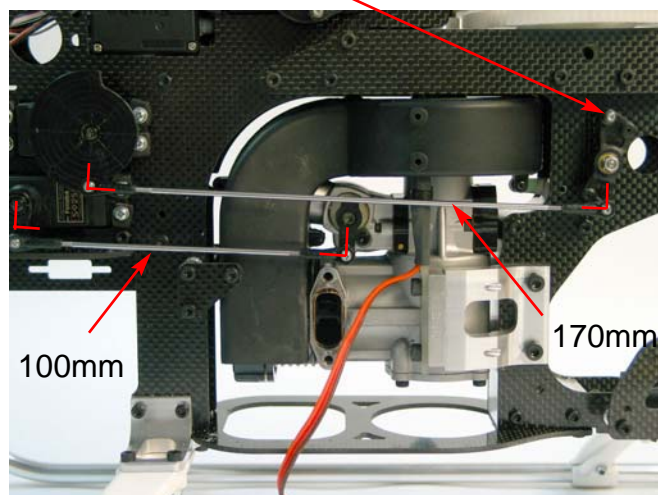

The 7mm spacer and 12 mm bolt is used as a carburetor shaft extension on YS engines



Step 21: Head modifications.

Bag #21 contents:

- 4 CX00-100-402 M2.5x10mm round button head socket cap screw
- 2 CX00-100-401 M2.5x8mm round button head socket cap screw
- 2 CX00-100-626 Mixing Arms with 2 flanged bearings each
- 2 CX00-100-625 Ratio modification blocks
- 2 CX00-100-630 Delta spacers with double balls.
- 3 CX00-100-627 35 mm threaded rods
- 6 CX00-100-302 M3 Flat washers (for delta spacer adjustment)

The Avant FX includes additional head modifications that optimize the response of the helicopter for extreme 3D flight. Being a lightweight helicopter it was necessary to adjust the ratios and delta response to match the different inertia effects imposed by a lighter mass. Flight penetration as well as collective pitch response have been adapted and increased for maximum momentum conservation throughout the maneuvers.

If it's not already filed then file the inner edge of the ratio block as shown in the picture to the right to prevent it from binding against the center hub. Once the ratio block is installed in place verify that it doesn't bind against it by swiveling the seesaw across its full swing and checking for contact between the ratio block and the center hub. Using the provided RED loctite install the ratio block by using a M2.5x8mm round button head screw first in the outer holes and then a M2.5x10mm round button head screw as indicated in the picture.

Round edge with a file

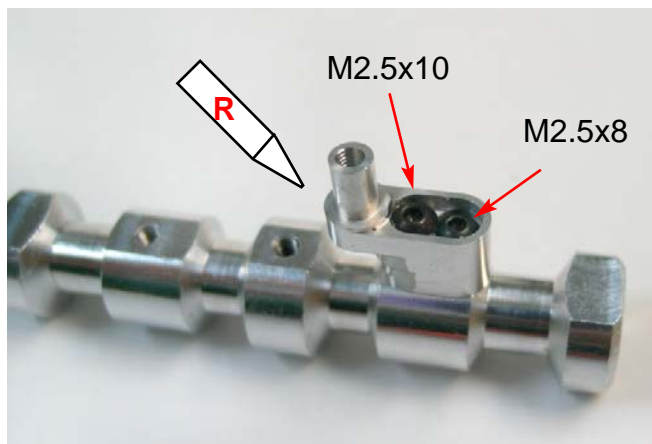

IMPORTANT !!!

Use the supplied **#262 Red Loctite** when installing the ratio block with the M2.5x8 and M2.5x10 screws. Other Red Loctite types can't be removed with heat.

Attention: Failure to use the correct length screws will lock the flybar inside the seesaw.

The effect of the ratio block is to change what percentage from the flybar action is applied to the blades. Repeat the process for the other side of the seesaw.

Copyright 2005 *CarbonXtreme*



Inner hole recommended
for initial setting



IMPORTANT NOTE !!!

When extracting the M2.5x8 and M2.5x10 screws that were installed with the #262 Red Loctite you **MUST USE HEAT from a heat gun or a torch**. Trying to extract the screws without heating the seesaw and the ratio block **will most likely strip the screw heads**

Install two [Hirobo 2525-006 5mm balls](#) with the [2532-031 M2 X 6mm screws](#) on the mixing arm as shown on the picture to the left. It is highly recommended that initially the inner hole is used.

Use Blue Loctite to install a M2.5x10mm round button head screw into the ratio block. Install the arm on the ratio block as shown on the picture to the right. Notice that the beginning of the 2.5mm thread is lightly scored inside the sleeve for a tight fit and the main thread is at the bottom of the sleeve.

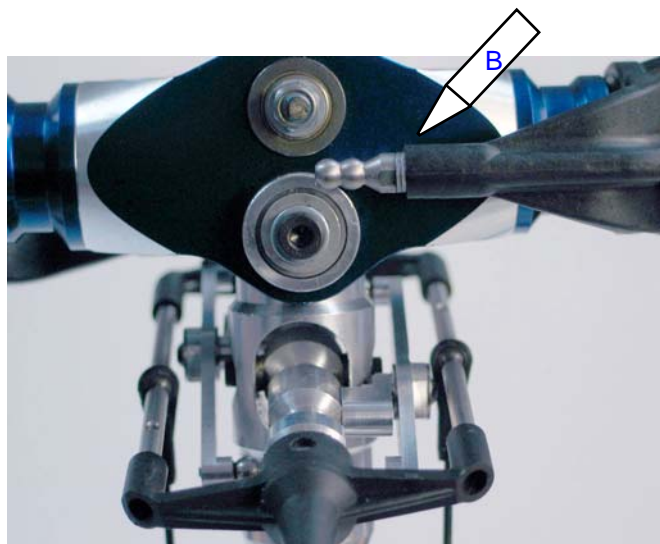
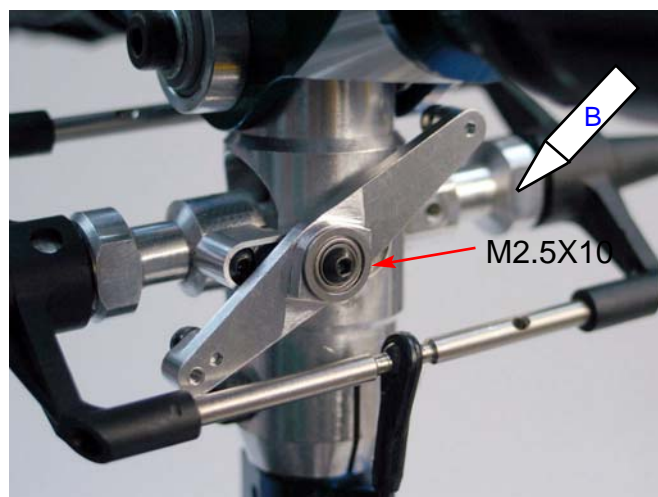

Use two M3 washers and install the Delta spacers in place using blue Loctite. If you want more delta action for blades that are too stable or want even more response then install the delta spacer without one or both washers. It's recommended that the two washers are installed initially.

NOTE:

The Avant FX has been designed to have a very high cyclic response with the stock paddles. It's strongly recommended that those are used initially with at least the brass weights installed before trying some higher mobility ones.

Avant FX Assembly Manual

Install two *Hirobo ball links* at both ends of each one of the three 35 mm pushrods. install them in the ends of all the CCPM levers and install the other end in the balls of the swashplate as indicated in the picture below.

Set your pitch/throttle radio stick to the middle of the travel and adjust the servo's individual subtrims so that all CCPM levers are horizontally aligned. Keeping the levers all horizontally aligned adjust the length of the three 35 mm pushrods so that the CCPM guide pin is in the middle of the travel inside the slot of the CCPM guide.

This will serve as a reference for the rest of the setup. After adjusting their lengths un-install them again and measure and compare the three 35mm pushrods. Measure their lengths and average their lengths. Use that average to adjust the length of all of them to be exactly the same

Adjust rod length
to make washout
arms horizontal

Guide pin should
be in the middle
of the slot

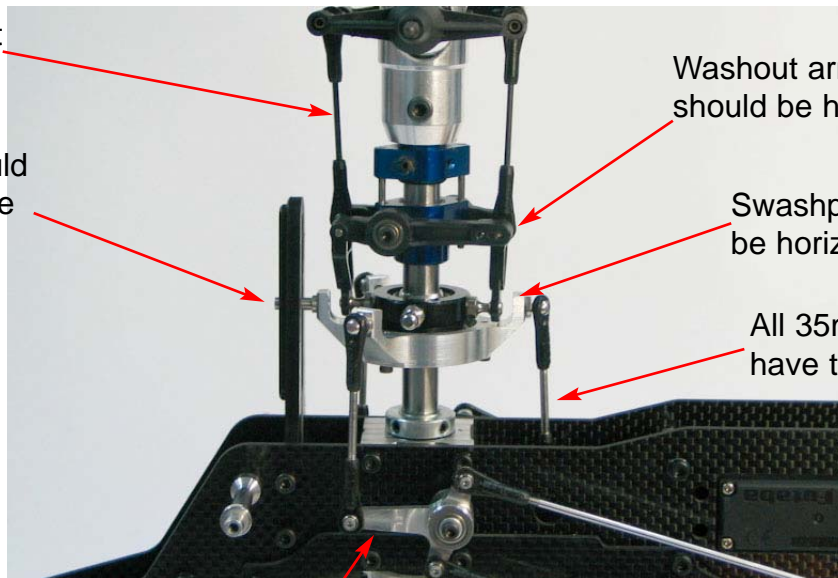

Washout arms
should be horizontal

Swashplate should
be horizontal

All 35mm rods should
have the same length

All levers should be horizontal

Reinstall the 35mm rods in place and make sure the swashplate is perfectly leveled. This should mean also that all levers are horizontally aligned.

Make sure they are horizontal by adjusting the pitch/throttle stick to compensate. Double check that the guide pin is in the middle of the travel inside the slot. If needed adjust the three lengths of the rods up or down by turning the exact number of turns or half turns up or down on all of them.

Once the swashplate is leveled this way connect the washout arms to the swashplate balls. Adjust the Hirobo links between the washout arms and the flybar balls so that the washout arms are horizontally aligned.

As a last step connect the Hirobo links from the swashplate to the mixing arms and adjust them so that the mixing arms are horizontal. Connect the arms to the bladeholders and make sure the blades are at zero degrees of pitch.

Step 22: Tailboom and rudder pushrod installation.

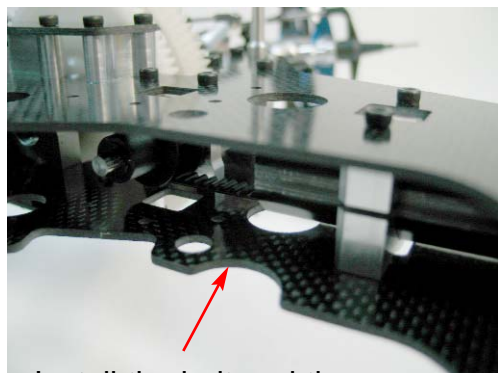

Install the belt and the third bearing block

Bag #23 contents:

2 CX00-100-702 White Pushrod guides
 2 CX00-100-405 M2.5x12mm screw
 2 CX00-100-310 M2.5 plain nuts
 1 CX00-100-704 Tail pushrod coupler
 4 CX00-100-628 50mm threaded rods
 2 CX00-100-706 420mm carbon pushrods
 1 CX00-100-614 Tail pulley shaft bearing block



Install the [hirobo tail boom assembly](#) into the boomclamps as assembled following the original hirobo instructions. Do not pull the boom or tighten the tailboom clamps yet. Using four M3x6mm screws and blue loctite install the third bearing block with the bearing opening facing the belt pulley. After the bearing is in place follow the hirobo instructions to tighten the belt and secure the boomclamp by tightening the lower boomclamp screws.

Locate the four 50mm threaded rods. Notice there is one side that has a long thread while the other has a regular shorter thread length.



Locate the four 50mm threaded rods. Notice there is one side that has a long thread while the other has a regular shorter thread length.



The long thread is used as an anchor for the J-B Weld inside the carbon pushrods.

The preferred method of securing the rods into the carbon pushrods is by gluing them with J-B Weld. Alternatively you can also use 2 hour epoxy. Do not use 5 minute epoxy since there is need to adjust the lengths of the pushrods for a longer time than the 5 minute it takes for the 5 minute epoxy to cure.

Mix up some J-B Weld and coat all the long thread of two 50mm threaded rods with J-B Weld Insert only one 50mm threaded rods into the end of each one of the carbon pushrods. Clear the excess and make sure it goes inside all the way until only about 10 mm of the short thread is exposed. This is necessary for the plastic coupler to work. leave it on the side and let it cure overnight.

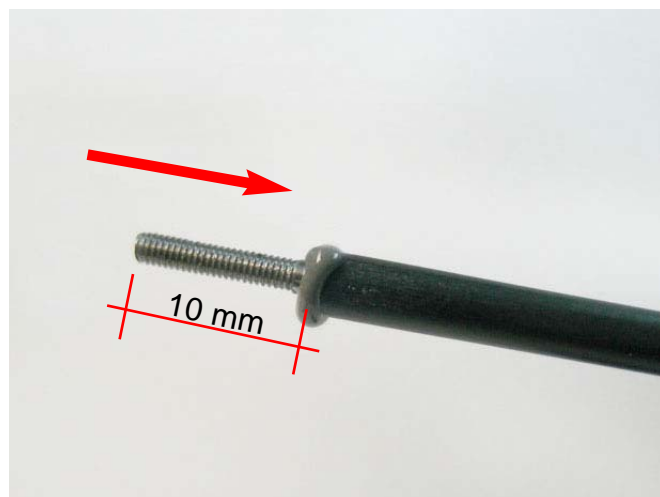

Avant FX Assembly Manual

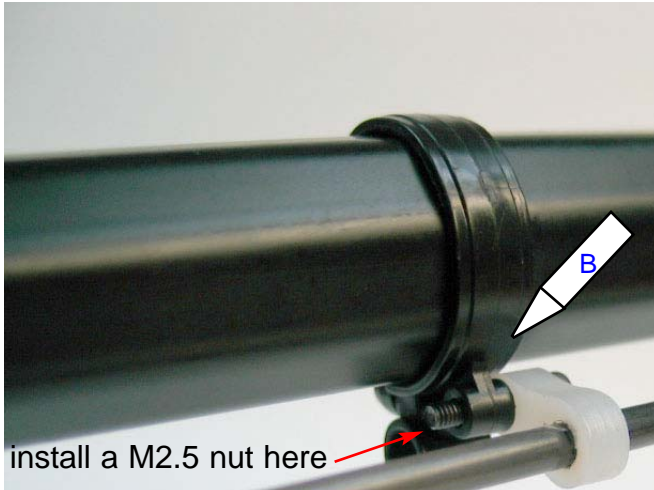

Using the M2.5mm screw install the pushrod guide on the [Hirobo 0414-137 control rod guide](#) as shown in the picture to the left. Use loctite and install the M2.5 plain nut in the end indicated in the picture.



Repeat the process and install the other pushrod guide.



Using blue loctite screw each end of the cured pushrod threads as shown on the picture to the left.

Install the other two 50mm threaded rods as explained before but this time leave about 20mm of the short threaded rod exposed. Install the ball links and then adjust the depth at which the threaded pushrod sits before it cures as required to make the rudder bell-

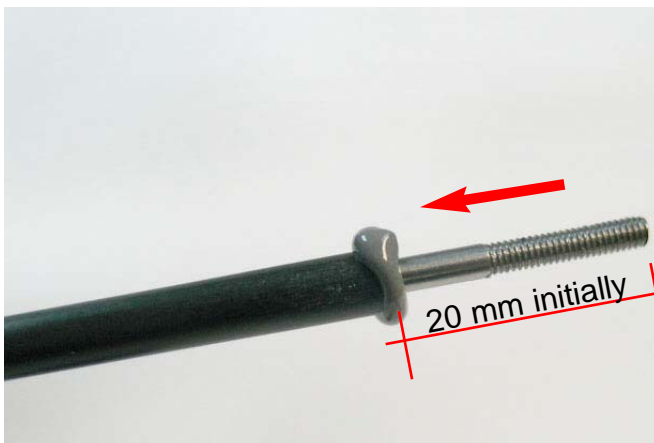

crank arm and tail control arm match the ball link's centers. Let the J-B Weld cure overnight. Once the J-B Weld has cured if additional fine tuning is necessary it can be done by screwing the ball link inward or outward as required.

Step 23: Fins and Vinyl sticker installation.

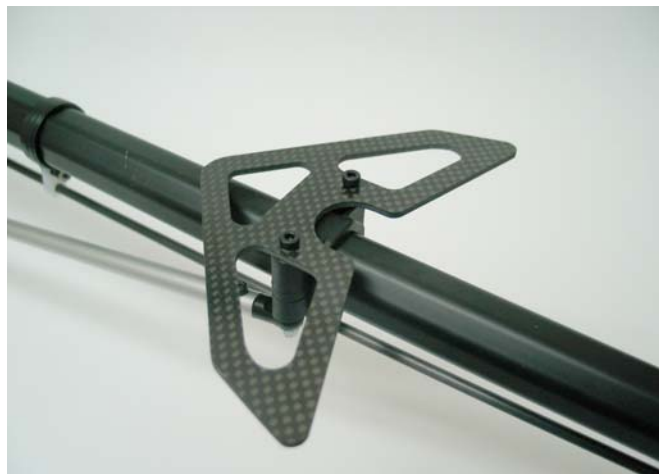

Using 2 M3x35mm socket head cap screws, 2 M2 Flat Washers and 2 M3 locknuts install the horizontal fin as shown on the picture above.

Using 2 M3x12mm socket head cap screws and 2 M3 locknuts install the vertical fin as shown on the picture to the right. Don't forget to pass the tail pushrod through the third ring as shown in the picture to the right. No white pushrod guides are necessary here. All three supports are necessary for correct rod support and gyro operation.

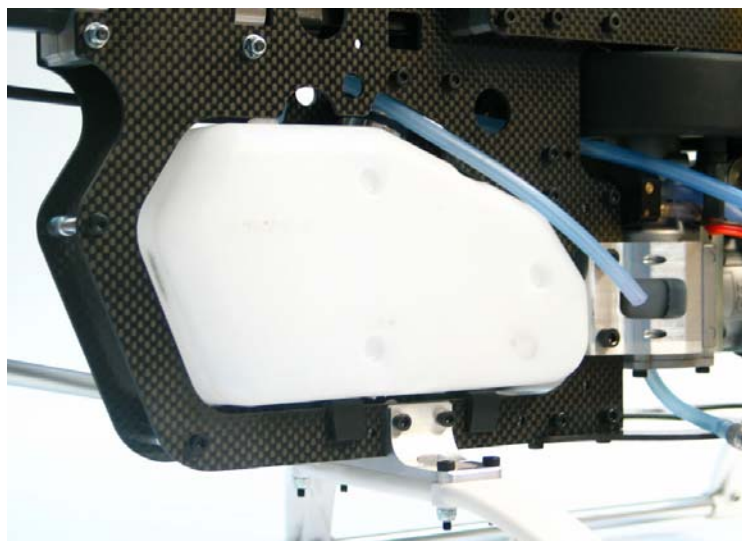

Place an M3 Washer on the M3x40mm screw and pass it through the boom support end and the 7mm spacer. Install the plate and a 17mm spacer in the back hole as well as a M3x25mm screw and 17mm spacer in the front hole. Using blue loctite install the assembly in place.

Bag #23 contents:

- 1 CX00-100-501 Vertical Fin
- 1 CX00-100-502 Horizontal Fin
- 1 CX00-100-500 Micro Fin
- 2 CX00-100-428 M3x35mm screw
- 2 CX00-100-423 M3x12mm screw
- 3 CX00-100-302 M3 Flat Washers
- 4 CX00-100-320 M3 locknuts
- 1 CX00-100-601 7mm spacer
- 3 CX00-100-602 17 mm spacers
- 2 CX00-100-427 M3x25mm screw
- 1 CX00-100-429 M3x40mm screw



Pass the tail pushrod through the third ring as shown here. No white pushrod guides are necessary here.

Install the tank as shown on the picture to the left. Make sure to bend the pickup tube enough so that the tank fuel line doesn't touch the lower bearing blocks. The air vent tubing should come out through the small rectangular window as shown. To prevent cuts in the fuel line all places where the fuel line pass through the frames should have its edges rounded by sanding with #400 sanding paper.



Step 24: Vinyl sticker installation.

Bag #24 contents:

- 2 CX00-100-804 CarbonXtreme logo stickers in carbon looking vinyl
- 2 CX00-100-805 Canopy Avant logo Sticker in carbon looking vinyl
- 2 CX00-100-806 Canopy Left Stickers in carbon looking vinyl
- 2 CX00-100-807 Canopy Right Stickers in carbon looking vinyl



Once the canopy is painted with the base colors coat you can apply the vinyl stickers before applying the clear coat finish.

Spray some soapy water on the canopy before applying the front and top stickers to help slide them in place. once in place let it dry overnight before applying clear coat. After they are dry install the ones with the backing in place.

Use the diagrams below as a guide to where the stickers are installed on the canopy.

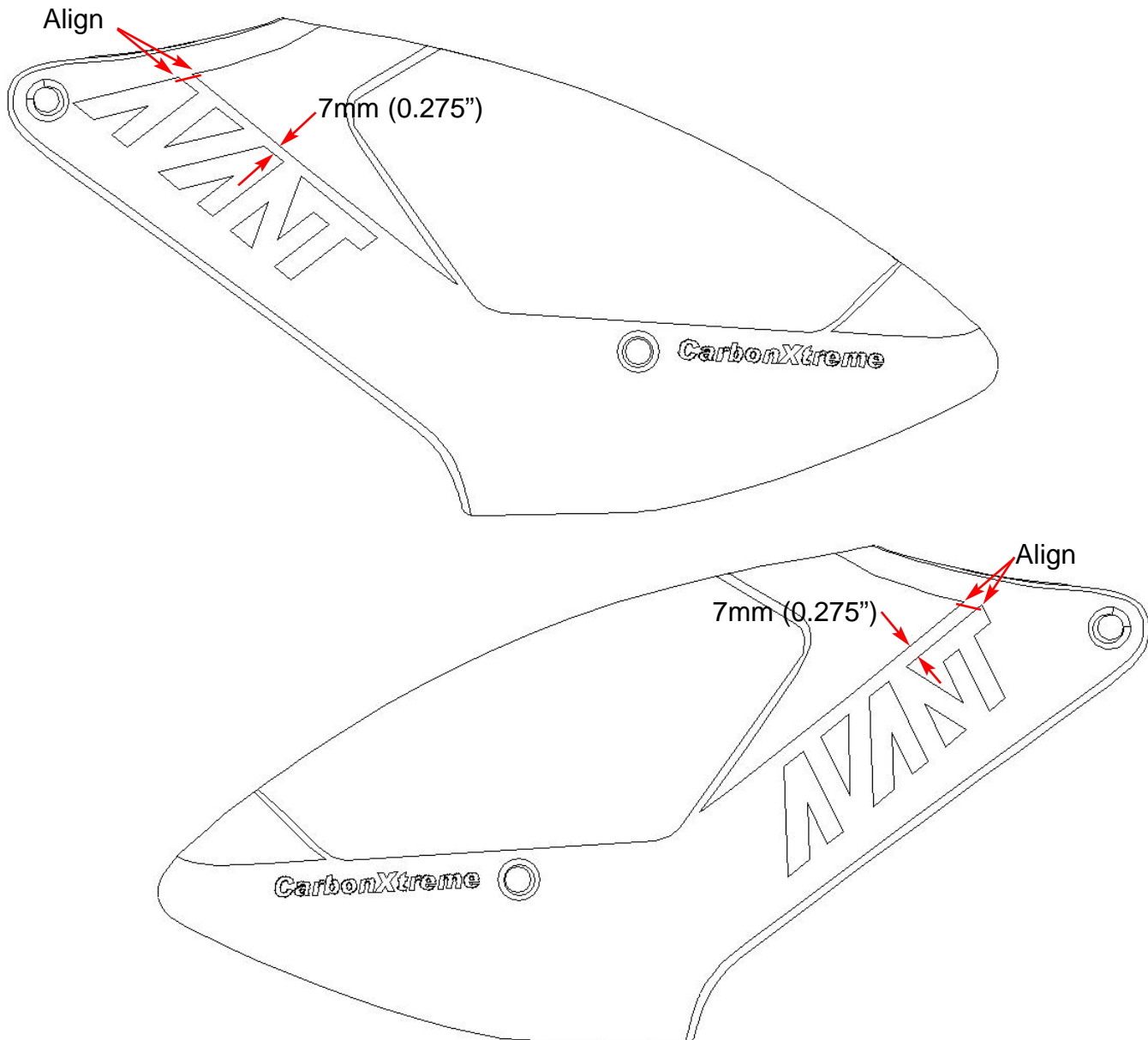

Step 25: Velcro strips installation.

Bag #25 contents:
1 CX00-100-803 Strip of Velcro

Cut the strip of Velcro to the following sizes:

- 2 strips of 140mm each for the Gyro control box and the governor control box
- 1 strip of 170mm Gyro sensor
- 2 strips of 275mm each for the battery and the receiver
- 1 strip of 400mm for the tank strap

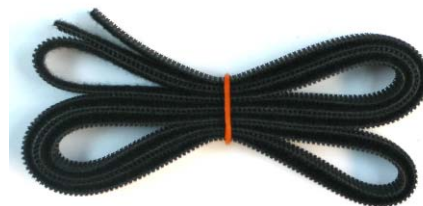

Miscellaneous bags:

#242 Blue Loctite and #262 Red Loctite are included in the kit



A bag with one extra spare for all screw, washers and nuts is included in case one is missing or to replace any defective one that needs replacement

Avant FX Assembly Manual

For MP-II users there will be a need to cut a small corner in the canopy to clear the MP-II header.

Additional Pictures and instructions.

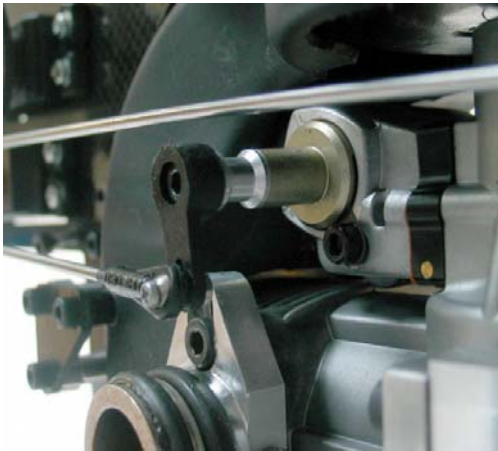

If you're using a YS engine and a Hatori muffler you will need to use the provided 7mm spacer and M3x12mm screw included in bag #23 to extend the reach of the carburetor arm.

Install the supplied brass sleeve from bag 22 here

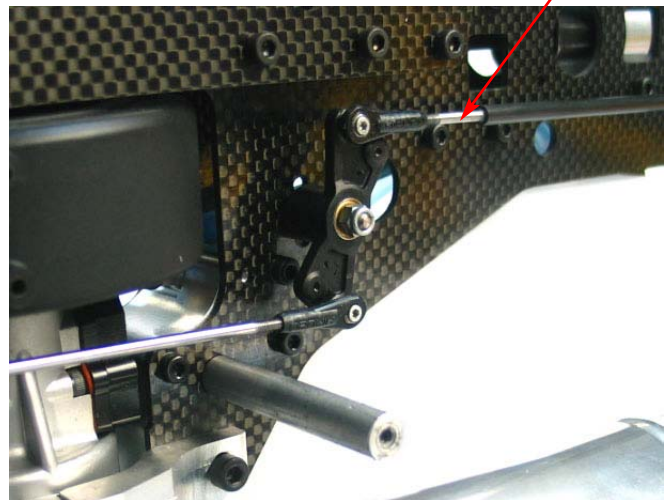

Extra holes are provided for the installation of muffler posts as shown on the picture to the right.

The same holes on the opposite side can be used to install a 17mm spacer to hold header tanks.



Appendix A: Installation of the Brass Sleeves:

Make sure the inside of the carbon rod is clean and free of dust. Use some alcohol to clean the inside. Use also alcohol to clean the inside of the sleeve and the outside of the threaded rod. No oil residue should be left anywhere

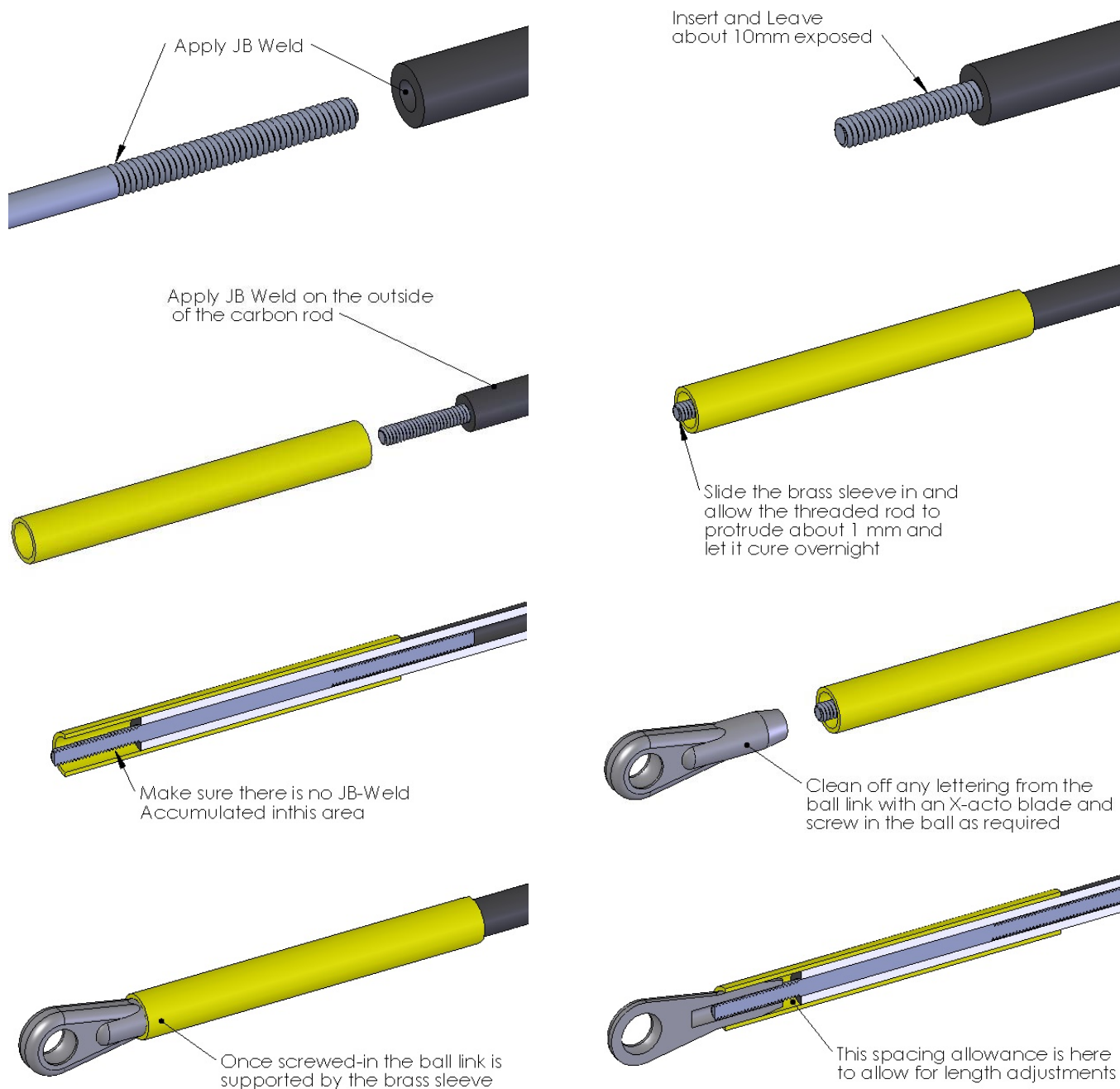

Install one sleeve in the front of the rudder pushrod at the X-Lever and one in the back at the tail pitch lever.

Thanks for selecting the AVANT FX. We appreciate your business. If you have any questions or need any support please don't hesitate to contact us at www.CarbonXtreme.com.

CarbonXtreme